



## Reed Switch Catalogue

[www.StandexElectronics.com](http://www.StandexElectronics.com)

## Standex Product Offerings:

<p><b>Low-Frequency Magnetics</b></p>	
<p><b>High-Frequency Magnetics</b></p>	
<p><b>Antenna &amp; RF Magnetics</b></p>	
<p><b>Magnetic Reed Switches, Sensors &amp; Relays</b></p>	
<p><b>Hermetic Connector Products</b></p>	
<p><b>Precision Stamping &amp; Value-Added Packaging</b></p>	
<p><b>HID Lighting Products</b></p>	

## Standex Global Locations

### Divisional Headquarters – USA:

Standex Electronics, Inc.  
 4538 Camberwell Road  
 Cincinnati, Ohio 45209 USA  
 Phone: +513 871 3777  
 Fax: +513 871 3779  
 Toll Free - US: 866-STANDEX (866-782-6339)

### United Kingdom:

Standex Electronics (U.K.) Ltd  
 40 Morley Road, Tonbridge  
 Kent, TN9 1RA, UK  
 Phone +44 1732 77 10 23  
 Fax +44 1732 77 01 22

### Canada:

Standex Electronics/ATC-Frost Magnetics, Inc.  
 1130 Eighth Line, Oakville  
 Ontario, L6H 2R4 Canada

### China:

Standex Electronics (Tianjin) Co., Ltd.  
 No.4 Factory Building,  
 61#, Huasheng Road,  
 East of Jinwei Ave.,  
 Beichen High-Tech Industrial Park  
 Tianjin 300402, China  
 Tel: +86 22 86 99 68 81~5  
 Fax: +86 22 86 99 68 86

### Mexico:

Standex Electronics, S.I. de Mexico S.A. de  
 C.V.  
 Calle Primera #2550, Agua Prieta  
 Sonora Mexico 84270

## **Contents:**

<b>About Standex Electronics</b>	<b>4</b>
<b>Mission Statement</b>	<b>4</b>
<b>History of Standex Electronics</b>	<b>4</b>
<b>Professional Grade Reed switch quick selection chart</b>	<b>5</b>
<b>GR501</b>	<b>6</b>
<b>GP501</b>	<b>8</b>
<b>GR560</b>	<b>10</b>
<b>GP560</b>	<b>12</b>
<b>GR100</b>	<b>14</b>
<b>GP100</b>	<b>16</b>
<b>NL126</b>	<b>18</b>
<b>PR560</b>	<b>20</b>
<b>PR126</b>	<b>22</b>
<b>Custom lead forming and customer specific requirements</b>	<b>24</b>
<b>Commercial Grade Reed switch quick selection chart</b>	<b>26</b>
<b>TS501</b>	<b>27</b>
<b>TR501</b>	<b>29</b>
<b>TS560</b>	<b>31</b>
<b>TR560</b>	<b>33</b>
<b>TS100</b>	<b>35</b>
<b>TR100</b>	<b>37</b>
<b>Reed switch structure and operation</b>	<b>39</b>
<b>Reed switch actuation</b>	<b>39</b>
<b>Typical Applications</b>	<b>41</b>
<b>Glossary</b>	<b>41</b>



## About Standex Electronics

Standex Electronics, Inc. is a subsidiary of **Standex International Corporation**; symbol SXI on the New York Stock Exchange. Standex Electronics is registered to quality standard **ISO/TS 16949:2002**. Standex Electronics divisional headquarters is located in Cincinnati, Ohio, USA. In addition to the factory in Ohio, facilities are also maintained in Agua Prieta, Mexico; Arizona, USA; Kent, UK; Ontario, Canada; and Tianjin, China. Standex Electronics is a manufacturer of electronic components and subassemblies including, inductors, chokes, transformers, antenna coils, reed switches, reed relays, proximity sensors, fluid-level sensors, connectors, progressive die stampings, insert-moulded plastic components, and custom products combining many of the above components. In addition to manufacturing facilities, Standex Electronics also maintains a sophisticated testing laboratory. Standex Electronics specializes in electro-mechanical engineered solutions.

With laboratory testing capabilities as diverse as the products we manufacture, Standex Electronics offers laboratory testing support that is unmatched within our industry.

- Thermal Shock Testing (-70<sup>o</sup>C to +200<sup>o</sup>C, LN2 boost assures less than a 5 minute air-temperature recovery time).
- Thermal Cycle Testing (-68<sup>o</sup>C to +177<sup>o</sup>C).
- Humidity Testing (-18<sup>o</sup>C to +93<sup>o</sup>C, 98% RH, cycle temp or steady state).
- Vibration Testing (Sine or Random profile, 1" pk-pk displacement, 0 to 80 g pk, 5 to 2000 HZ).
- Mechanical Shock Drop Testing (½ sine 50g 11ms, ½ sine 1500g .5ms, or saw tooth 100g 6ms).
- Hi Temp Testing (Up to +260<sup>o</sup>C).
- Salt Fog Testing.
- Solderability Testing.
- Lead Pull Testing.
- Cross-Sectioning.
- Polishing.
- Microscopic Inspection.
- X-Ray.



What differentiates Standex Electronics from its competition is turnkey solutions, from concept, through design, pre-production, qualification testing, manufacturing, and service after the sale.

## Mission Statement

Standex Electronics is committed to providing products that offer an unmatched value through continuous improvement and employee involvement. The company conducts its business by recognizing safety, morale and professional development of all employees.

## History of Standex Electronics

Standex Electronics was established in 1969 when Standex International purchased the Paul Smith Company. Standex Electronics has grown over the years by developing new products internally as well as by synergistic acquisition. Acquisitions, and strategic license agreements, include Underwood Electric (1973), Van Products (1974), Comtelco (1978), ATR Coil (1998), Classic Coil Winding (1998), ATC-Frost Magnetics (2001), Cin-Tran (2002), Magnetico (2003) and Lepco (2004).

## Professional grade reed switch quick selection chart:

All Standex switches are UL recognised  
All Standex switches are RoHS compliant.

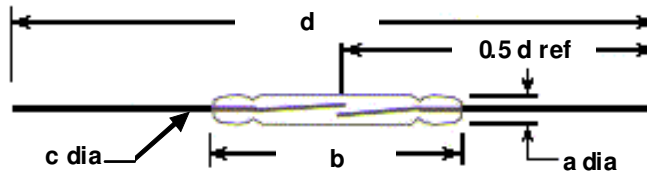

Switch type	GR501 / GP501	GR560 / GP560	GR100 / GP100	NL126	PR560	PR126
<b>Physical Characteristics</b>						
Glass dia max - a	2.3mm	2.3mm	2.5mm	2.5mm	2.3mm	2.5mm
Glass length max - b	12.7mm	14.2mm	20.3mm	20.3mm	14.2mm	20.3mm
Lead dia nominal - c	0.45mm	0.6mm	0.6mm	0.7mm	0.6mm	0.7mm
Overall length - d	54.0mm	54.0mm	54.0mm	54.0mm	54.0mm	54.0mm
<b>Electrical Characteristics</b>						
Contact material	Rh / PGM alloy	Rh / PGM alloy	Rh / PGM alloy	Rhodium	Rhodium	Rhodium
Power rating maximum	10 VA	10 VA	10 VA	50 VA	10 VA	70 VA
Switching current maximum	0.5 Amp DC & AC	1.0 Amp DC & AC	1.0 Amp DC & AC	1.5 Amp DC & AC	1.0 Amp DC & AC	1.5 Amp DC & AC
Carry current maximum	0.8 Amp DC & AC	1.5 Amp DC & AC	1.5 Amp DC & AC	2.5 Amp DC & AC	1.5 Amp DC & AC	2.5 Amp DC & AC
Switching voltage maximum	100 VDC 125 VAC	100 VDC 125 VAC	100 VDC 150 VAC	200 VDC 150 VAC	250 VAC 100 VDC	300 VAC 200 VDC
Breakdown volt min @20AT	200 VDC	200 VDC	250 VDC	250 VDC	600 VDC	750 VDC
Contact resistance	150 mΩ	100 mΩ	100 mΩ	100 mΩ	100 mΩ	100 mΩ
Insulation resistance minimum	10 <sup>12</sup> Ω	10 <sup>12</sup> Ω	10 <sup>12</sup> Ω	10 <sup>12</sup> Ω	10 <sup>12</sup> Ω	10 <sup>12</sup> Ω
Contact capacitance pf maximum	0.3 pF	0.2 pF	0.2 pF	0.3 pF	0.2 pF	0.3 pF
<b>Operating Characteristics</b>						
Magnetic sensitivity, pull in range	7-30 AT	10-50 AT	10-60 AT	20-60 AT	20-40 AT	20-50 AT
Operate time, inc. bounce typ	1.0 msec	0.6 msec	0.8 msec	0.8 msec	0.6 msec	0.8 msec
Release time typical	0.1 msec	0.1 msec	0.1 msec	0.1 msec	0.1 msec	0.1 msec
Resonant Frequency	3.2 kHz	3.0 kHz	2.2 kHz	2.2 kHz	3.0 kHz	2.2 kHz
Vibration, 10-2000Hz maximum	50 G	50 G	40 G	30 G	50 G	30 G
Shock, 11-ms. ½ sine wave max	100 G	100 G	100 G	100 G	100 G	100 G
Operating temperature	-40°C to +125°C	-40°C to +125°C	-40°C to +125°C	-40°C to +125°C	-40°C to +125°C	-40°C to +125°C
Storage temperature	-50°C to +155°C	-50°C to +155°C	-50°C to +155°C	-50°C to +155°C	-50°C to +155°C	-50°C to +155°C

## GR501

- Sub miniature reed switch with rhodium alloy contacts.
- Designed for applications where the available magnetic field is very low.
- Useful for "wide-gap" security system applications and other magnetic systems requiring long operating distances with permanent magnets.

### Physical Characteristics:

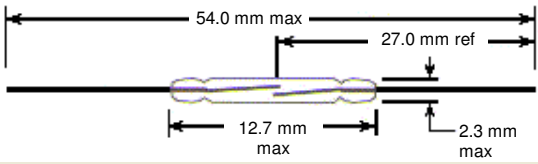

Glass Diameter (Max.)	2.3mm
Glass Length (Max.)	12.7mm
Lead Dia. (Nominal)	0.45 mm
Overall Length (Max.)	54.0 mm

### Electrical Characteristics:

Contact Arrangement	Form A (SPST), Centre Gap
Contact Material	Rhodium
Power Rating <sup>1</sup>	10VA maximum
Switching Current (Max.)	0.5 Amp. DC, 0.5 Amp. AC
Carry Current (Max.)	0.8 Amp. DC, 0.8 Amp. AC
Switching Voltage (Max.)	100 VDC, 125 VAC
Breakdown Voltage (Min. @20AT) <sup>2</sup>	200 Volts DC
Contact Resistance <sup>3</sup>	150 Milliohms
Insulation Resistance (Min.)	10 <sup>12</sup> ohms
Contact Capacitance (pf Max.)	0.3 pf

- The specification for VA rating may sometimes be exceeded for less sensitive (higher AT) switches, and should be decreased for very sensitive (lower AT) switches. Standex Electronics will run life tests specific to a customers load upon request.
- Breakdown voltage is measured in the presence of an ionising source. Switch leakage current is limited to 100 microamperes
- Contact resistance measurements are made at 10ma from a 1-volt source, with 50% overdrive, using a 4-wire (Kelvin) measuring system. Contact probes are located on 43 mm centres.

### Minimum Switching Life with Standard Test Loads, using 20AT switch:

Voltage	5 VDC	10 VDC	12 VDC	24 VDC	100 VDC	125 VAC
Current	2 mA	1 A	10 mA	10 mA	100 mA	80 mA
Life	100 x 10 <sup>6</sup>	0.5 x 10 <sup>6</sup>	10 x 10 <sup>6</sup>	2 x 10 <sup>6</sup>	0.5 x 10 <sup>6</sup>	0.5 x 10 <sup>6</sup>

Note: End of life is defined as contact resistance exceeding one ohm and/or failure to operate.

## Operating Characteristics:

Magnetic Sensitivity (Range - Pull In)	7 to 30 Ampere Turns
Magnetic Sensitivity (Range - Drop Out)	(See chart below)
Operate Time, including bounce (typ.)	1.0 Milliseconds
Release Time (typ.)	0.1 Milliseconds
Resonant Frequency (typ.)	3.2 kHz
Vibration, 10-2,000 Hz (G's Max.)	50 G
Shock, 11-ms. 1/2 Sine wave (G's Max.)	100 G
Operating Temperature	-40°C to + 125°C
Storage Temperature	-50°C to + 155°C

## Charts

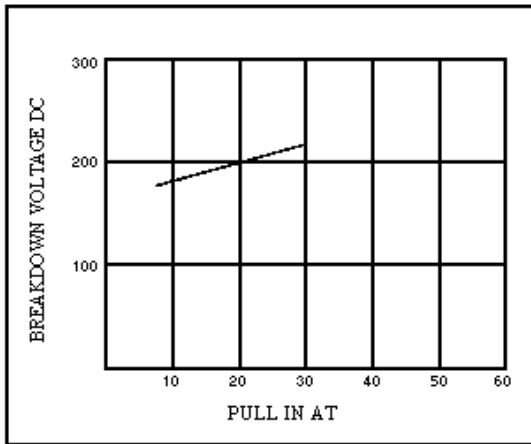

Breakdown Voltage Plotted Against Pull-In Ampere Turns

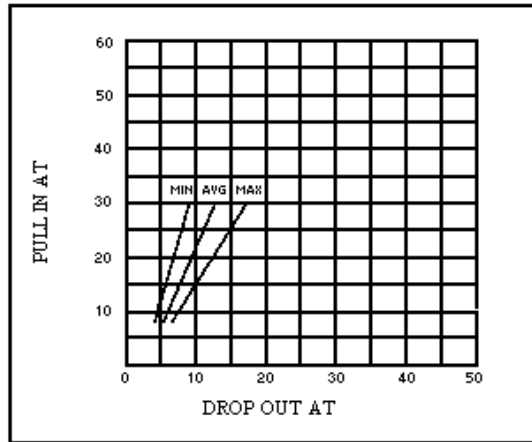

Pull-In Ampere Turns Plotted Against Drop-Out Ampere Turns

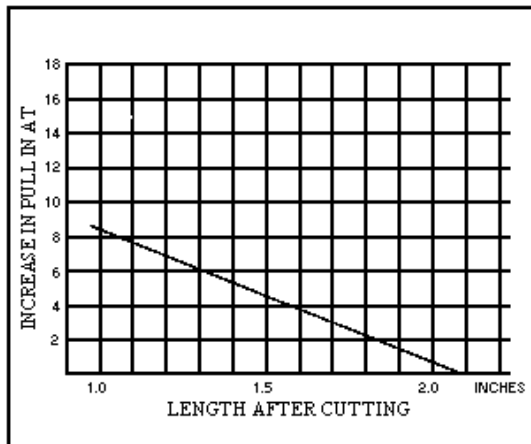

Change In Pull-In Ampere Turns After Switch Lead Cutting

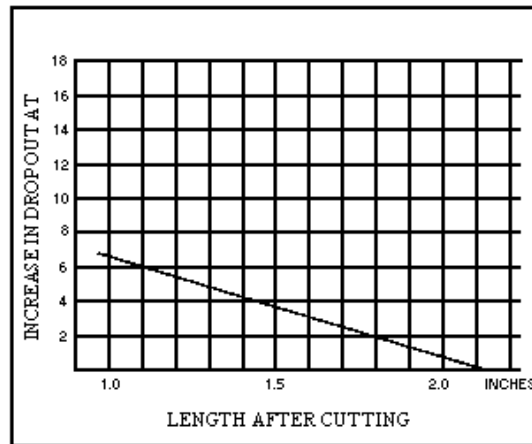

Change In Drop-Out Ampere Turns After Switch Lead Cutting

© Standex Electronics Inc.

[www.StandexElectronics.com](http://www.StandexElectronics.com)

Cincinnati, Ohio USA  
Phone +513 871 3777  
Fax +513 871 3779

Tonbridge, United Kingdom  
Phone +44 1732 77 10 23  
Fax +44 1732 77 01 22

Tianjin, China  
Tel: +86 22 86 99 68 81~5  
Fax: +86 22 86 99 68 86

## GP501

- Sub miniature reed switch with PGM alloy contacts.
- Designed for applications where the available magnetic field is very low and/or a high stability contact resistance is required
- Useful for "wide-gap" security system applications and other magnetic systems requiring long operating distances with permanent magnets.

### Physical Characteristics:

Glass Diameter (Max.)	2.3mm
Glass Length (Max.)	12.7mm
Lead Dia. (Nominal)	0.45 mm
Overall Length (Max.)	54.0 mm

### Electrical Characteristics:

Contact Arrangement	Form A (SPST), Centre Gap
Contact Material	PGM alloy
Power Rating <sup>1</sup>	10VA maximum
Switching Current (Max.)	0.5 Amp. DC, 0.5 Amp. AC
Carry Current (Max.)	0.8 Amp. DC, 0.8 Amp. AC
Switching Voltage (Max.)	100 VDC, 125 VAC
Breakdown Voltage (Min. @20AT) <sup>2</sup>	200 Volts DC
Contact Resistance <sup>3</sup>	150 Milliohms
Insulation Resistance (Min.)	10 <sup>12</sup> ohms
Contact Capacitance (pf Max.)	0.3 pf

1. The specification for VA rating may sometimes be exceeded for less sensitive (higher AT) switches, and should be decreased for very sensitive (lower AT) switches. Standex Electronics will run life tests specific to a customers load upon request.
2. Breakdown voltage is measured in the presence of an ionising source. Switch leakage current is limited to 100 microamperes
3. Contact resistance measurements are made at 10ma from a 1-volt source, with 50% overdrive, using a 4-wire (Kelvin) measuring system. Contact probes are located on 43 mm centres.

### Minimum Switching Life with Standard Test Loads, using 20AT switch:

Voltage	5 VDC	10 VDC	12 VDC	24 VDC	100 VDC	125 VAC
Current	2 mA	1 A	10 mA	10 mA	100 mA	80 mA
Life	100 x 10 <sup>6</sup>	0.5 x 10 <sup>6</sup>	10 x 10 <sup>6</sup>	2 x 10 <sup>6</sup>	0.5 x 10 <sup>6</sup>	0.5 x 10 <sup>6</sup>

Note: End of life is defined as contact resistance exceeding one ohm and/or failure to operate.

© Standex Electronics Inc.

[www.StandexElectronics.com](http://www.StandexElectronics.com)



## Operating Characteristics:

Magnetic Sensitivity (Range - Pull In)	7 to 30 Ampere Turns
Magnetic Sensitivity (Range - Drop Out)	(See chart below)
Operate Time, including bounce (typ.)	1.0 Milliseconds
Release Time (typ.)	0.1 Milliseconds
Resonant Frequency (typ.)	3.2 kHz
Vibration, 10-2,000 Hz (G's Max.)	50 G
Shock, 11-ms. 1/2 Sine wave (G's Max.)	100 G
Operating Temperature	-40°C to + 125°C
Storage Temperature	-50°C to + 155°C

## Charts

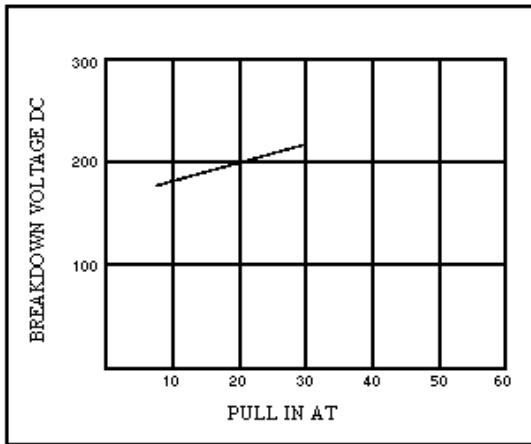

Breakdown Voltage Plotted Against Pull-In Ampere Turns

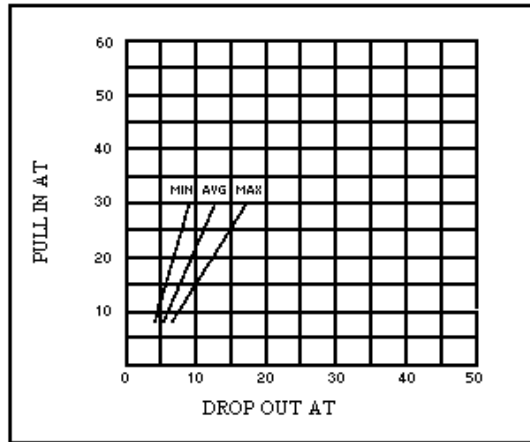

Pull-In Ampere Turns Plotted Against Drop-Out Ampere Turns

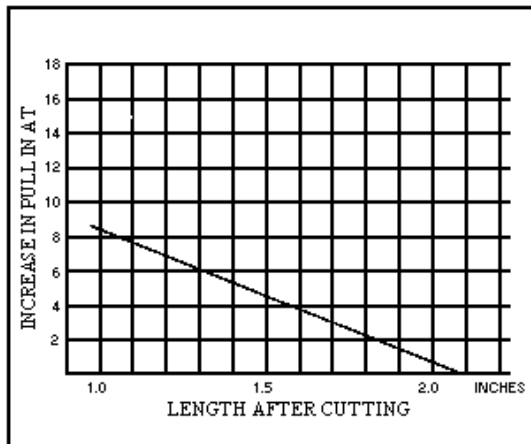

Change In Pull-In Ampere Turns After Switch Lead Cutting

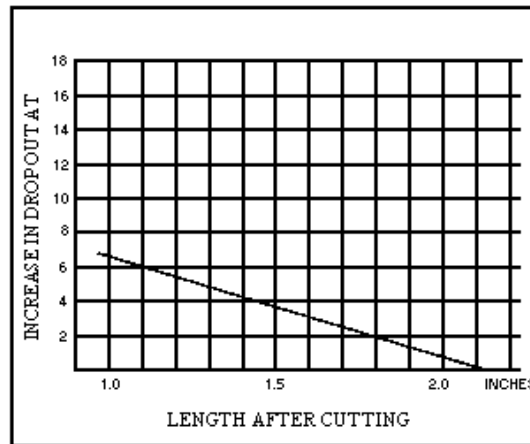

Change In Drop-Out Ampere Turns After Switch Lead Cutting

© **Standex Electronics Inc.**

[www.StandexElectronics.com](http://www.StandexElectronics.com)

Cincinnati, Ohio USA  
Phone +513 871 3777  
Fax +513 871 3779

Tonbridge, United Kingdom  
Phone +44 1732 77 10 23  
Fax +44 1732 77 01 22

Tianjin, China  
Tel: +86 22 86 99 68 81~5  
Fax: +86 22 86 99 68 86

## GR560

- General-purpose miniature reed switch with rhodium contacts.
- Gives superior life switching relatively heavy loads in a miniature glass package.
- Has the ability to maintain a low contact resistance over life switching light duty logic level loads.
- Normal applications include liquid level sensors, security systems, reed relays, proximity sensors and counting devices.

### Physical Characteristics:

Glass Diameter (Max.)	2.3mm
Glass Length (Max.)	14.2mm
Lead Dia. (Nominal)	0.6 mm
Overall Length (Max.)	54.0 mm

### Electrical Characteristics:

Contact Arrangement	Form A (SPST), Centre Gap
Contact Material	Rhodium
Power Rating <sup>1</sup>	10VA maximum
Switching Current (Max.)	1.0 Amp. DC, 1.0 Amp. AC
Carry Current (Max.)	1.5 Amp. DC, 1.5 Amp. AC
Switching Voltage (Max.)	100 VDC, 125 VAC
Breakdown Voltage (Min. @20AT) <sup>2</sup>	200 Volts DC
Contact Resistance <sup>3</sup>	100 Milliohms
Insulation Resistance (Min.)	10 <sup>12</sup> ohms
Contact Capacitance (pf Max.)	0.2 pf
<p>1. The specification for VA rating may sometimes be exceeded for less sensitive (higher AT) switches, and should be decreased for very sensitive (lower AT) switches. Standex Electronics will run life tests specific to a customers load upon request.</p> <p>2. Breakdown voltage is measured in the presence of an ionising source. Switch leakage current is limited to 100 microamperes.</p> <p>3. Contact resistance measurements are made at 10ma from a 1-volt source, with 50% overdrive, using a 4-wire (Kelvin) measuring system. Contact probes are located on 43 mm centres.</p>	

### Minimum Switching Life with Standard Test Loads, using 20AT switch:

Voltage	5 VDC	10 VDC	12 VDC	24 VDC	100 VDC	125 VAC
Current	2 mA	1 A	10 mA	10 mA	100 mA	80 mA
Life	100 x 10 <sup>6</sup>	1 x 10 <sup>6</sup>	100 x 10 <sup>6</sup>	5 x 10 <sup>6</sup>	1 x 10 <sup>6</sup>	1 x 10 <sup>6</sup>

Note: End of life is defined as contact resistance exceeding one ohm and/or failure to operate.

## Operating Characteristics:

Magnetic Sensitivity (Range - Pull In)	10 to 50 Ampere Turns
Magnetic Sensitivity (Range – Drop Out)	(See chart below)
Operate Time, including bounce (typ.)	0.6 Milliseconds
Release Time (typ.)	0.1 Milliseconds
Resonant Frequency (typ.)	3.0 kHz
Vibration, 10-2,000 Hz (G's Max.)	50 G
Shock, 11-ms. ½ Sine wave (G's Max.)	100 G
Operating Temperature	-40°C to + 125°C
Storage Temperature	-50°C to + 155°C

## Charts:

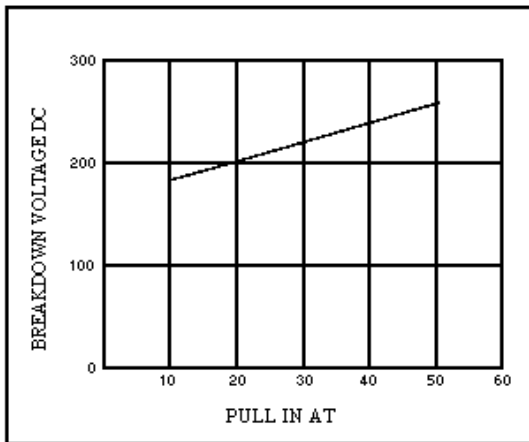

Breakdown Voltage Plotted  
Against Pull-In Ampere Turns

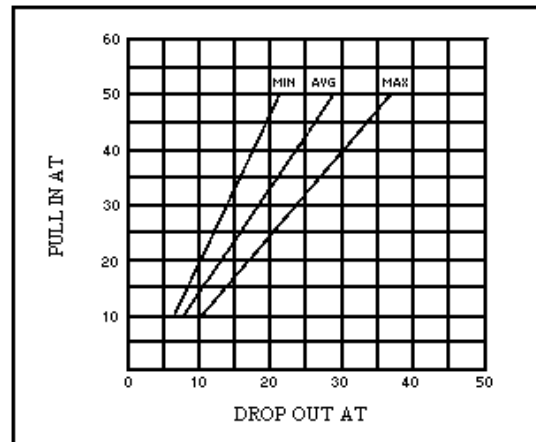

Pull-In Ampere Turns Plotted  
Against Drop-Out Ampere Turns

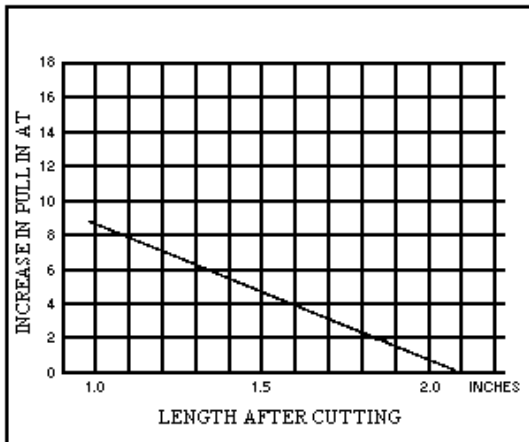

Change In Pull-In Ampere Turns  
After Switch Lead Cutting

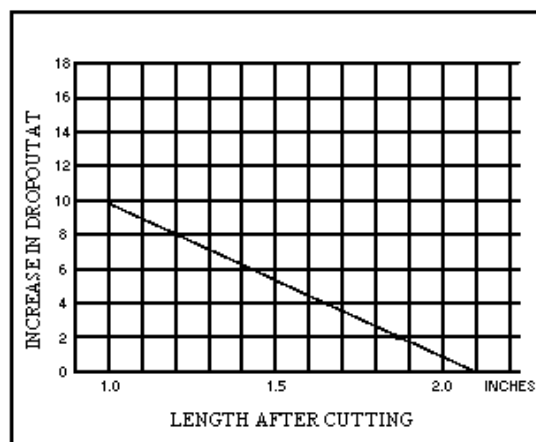

Change In Drop-Out Ampere Turns  
After Switch Lead Cutting

© **Standex Electronics Inc.**

[www.StandexElectronics.com](http://www.StandexElectronics.com)

Cincinnati, Ohio USA  
Phone +513 871 3777  
Fax +513 871 3779

Tonbridge, United Kingdom  
Phone +44 1732 77 10 23  
Fax +44 1732 77 01 22

Tianjin, China  
Tel: +86 22 86 99 68 81~5  
Fax: +86 22 86 99 68 86

## GP560

- General-purpose miniature reed switch with PGM alloy contacts.
- Gives superior life switching relatively heavy loads in a miniature glass package.
- High stability contact resistance.
- Normal applications include liquid level sensors, security systems, reed relays, proximity sensors and counting devices.

### Physical Characteristics:

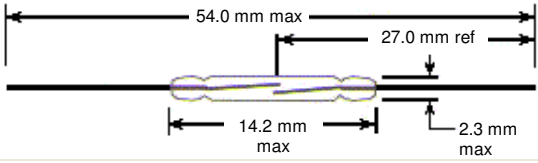
	
Glass Diameter (Max.)	2.3mm
Glass Length (Max.)	14.2mm
Lead Dia. (Nominal)	0.6 mm
Overall Length (Max.)	54.0 mm

### Electrical Characteristics:

Contact Arrangement	Form A (SPST), Centre Gap
Contact Material	PGM alloy
Power Rating <sup>1</sup>	10VA maximum
Switching Current (Max.)	1.0 Amp. DC, 1.0 Amp. AC
Carry Current (Max.)	1.5 Amp. DC, 1.5 Amp. AC
Switching Voltage (Max.)	100 VDC, 125 VAC
Breakdown Voltage (Min. @20AT) <sup>2</sup>	200 Volts DC
Contact Resistance <sup>3</sup>	100 Milliohms
Insulation Resistance (Min.)	10 <sup>12</sup> ohms
Contact Capacitance (pf Max.)	0.2 pf
<p>1. The specification for VA rating may sometimes be exceeded for less sensitive (higher AT) switches, and should be decreased for very sensitive (lower AT) switches. Standex Electronics will run life tests specific to a customers load upon request.</p> <p>2. Breakdown voltage is measured in the presence of an ionising source. Switch leakage current is limited to 100 microamperes.</p> <p>3. Contact resistance measurements are made at 10ma from a 1-volt source, with 50% overdrive, using a 4-wire (Kelvin) measuring system. Contact probes are located on 43 mm centres.</p>	

### Minimum Switching Life with Standard Test Loads, using 20AT switch:

Voltage	5 VDC	10 VDC	12 VDC	24 VDC	100 VDC	125 VAC
Current	2 mA	1 A	10 mA	10 mA	100 mA	80 mA
Life	100 x 10 <sup>6</sup>	1 x 10 <sup>6</sup>	100 x 10 <sup>6</sup>	5 x 10 <sup>6</sup>	1 x 10 <sup>6</sup>	1 x 10 <sup>6</sup>

Note: End of life is defined as contact resistance exceeding one ohm and/or failure to operate.

© Standex Electronics Inc.

[www.StandexElectronics.com](http://www.StandexElectronics.com)

## Operating Characteristics:

Magnetic Sensitivity (Range - Pull In)	10 to 50 Ampere Turns
Magnetic Sensitivity (Range – Drop Out)	(See chart below)
Operate Time, including bounce (typ.)	0.6 Milliseconds
Release Time (typ.)	0.1 Milliseconds
Resonant Frequency (typ.)	3.0 kHz
Vibration, 10-2,000 Hz (G's Max.)	50 G
Shock, 11-ms. ½ Sine wave (G's Max.)	100 G
Operating Temperature	-40°C to + 125°C
Storage Temperature	-50°C to + 155°C

## Charts:

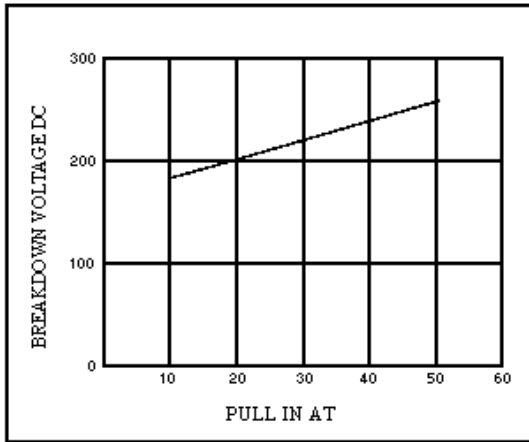

Breakdown Voltage Plotted Against Pull-In Ampere Turns

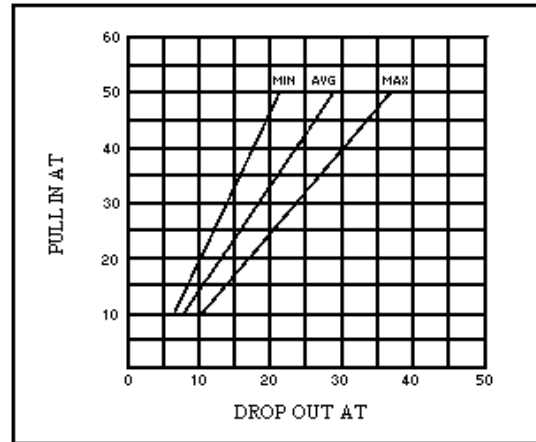

Pull-In Ampere Turns Plotted Against Drop-Out Ampere Turns

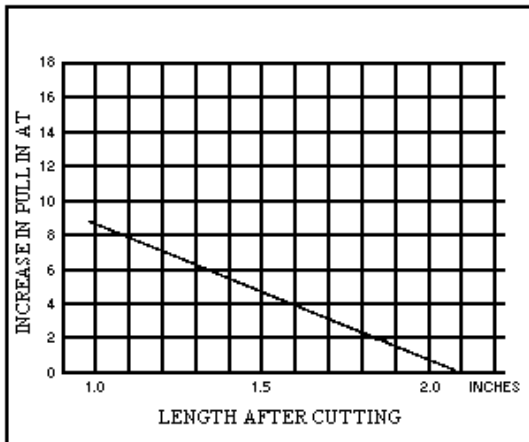

Change In Pull-In Ampere Turns After Switch Lead Cutting

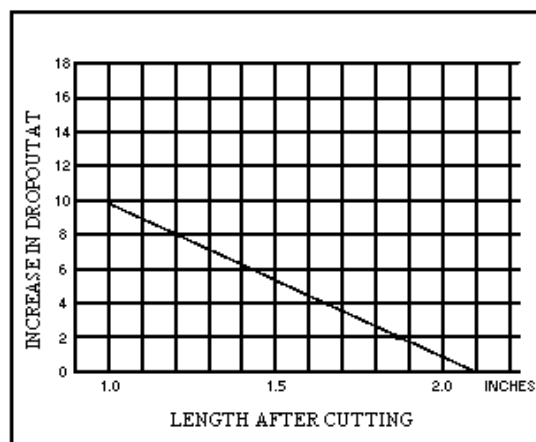

Change In Drop-Out Ampere Turns After Switch Lead Cutting

© **Standex Electronics Inc.**

[www.StandexElectronics.com](http://www.StandexElectronics.com)

Cincinnati, Ohio USA  
Phone +513 871 3777  
Fax +513 871 3779

Tonbridge, United Kingdom  
Phone +44 1732 77 10 23  
Fax +44 1732 77 01 22

Tianjin, China  
Tel: +86 22 86 99 68 81~5  
Fax: +86 22 86 99 68 86

## GR100

- General purpose reed switch with rhodium contacts.
- Designed to give superior life switching relatively heavy loads.
- Normal applications include liquid level sensors, security systems, reed relays, proximity sensors and counting devices.
- Ideally suited to handle normal 120 VAC loads.
- Maintains low contact resistance over life switching light duty logic level loads.

### Physical Characteristics:

Glass Diameter (Max.)	2.5mm
Glass Length (Max.)	20.3mm
Lead Dia. (Nominal)	0.6 mm
Overall Length (Max.)	54.0 mm

### Electrical Characteristics:

Contact Arrangement	Form A (SPST), Centre Gap
Contact Material	Rhodium
Power Rating <sup>1</sup>	10VA maximum
Switching Current (Max.)	1.0 Amp. DC, 1.0 Amp. AC
Carry Current (Max.)	1.5 Amp. DC, 1.5 Amp. AC
Switching Voltage (Max.) <sup>4</sup>	100 VDC, 150 VAC
Breakdown Voltage (Min. @20AT) <sup>2</sup>	250 Volts DC
Contact Resistance <sup>3</sup>	100 Milliohms
Insulation Resistance (Min.)	10 <sup>12</sup> ohms
Contact Capacitance (pf Max.)	0.2 pf
<ol style="list-style-type: none"> <li>1. The specification for VA rating may sometimes be exceeded for less sensitive (higher AT) switches, and should be decreased for very sensitive (lower AT) switches. Standex Electronics will run life tests specific to a customers load upon request.</li> <li>2. Breakdown voltage is measured in the presence of an ionising source. Switch leakage current is limited to 100 microamperes.</li> <li>3. Contact resistance measurements are made at 10ma from a 1-volt source, with 50% overdrive, using a 4-wire (Kelvin) measuring system. Contact probes are located on 43 mm centres.</li> <li>4. When switching 150 VAC please contact a Standex application engineer.</li> </ol>	

### Minimum Switching Life with Standard Test Loads, using 20AT switch:

Voltage	5 VDC	10 VDC	12 VDC	24 VDC	100 VDC	125 VAC	150 VAC
Current	2 mA	1 A	10 mA	10 mA	100 mA	80 mA	60 mA
Life	1000 x 10 <sup>6</sup>	2 x 10 <sup>6</sup>	100 x 10 <sup>6</sup>	8 x 10 <sup>6</sup>	2 x 10 <sup>6</sup>	2 x 10 <sup>6</sup>	1 x 10 <sup>6</sup>

Note: End of life is defined as contact resistance exceeding one ohm and/or failure to operate.

© Standex Electronics Inc.

[www.StandexElectronics.com](http://www.StandexElectronics.com)

## Operating Characteristics

Magnetic Sensitivity (Range - Pull In)	10 to 60 Ampere Turns
Magnetic Sensitivity (Range – Drop Out)	(See chart below)
Operate Time, including bounce (typ.)	0.8 Milliseconds
Release Time (typ.)	0.1 Milliseconds
Resonant Frequency (typ.)	2.2 kHz
Vibration, 10-2,000 Hz (G's Max.)	40 G
Shock, 11-ms. 1/2 Sine wave (G's Max.)	100 G
Operating Temperature	-40°C to + 125°C
Storage Temperature	-50°C to + 155°C

### Charts:

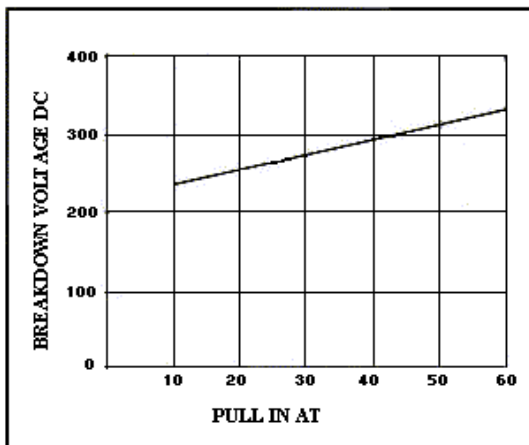

Breakdown Voltage Plotted  
Against Pull-In Ampere Turns

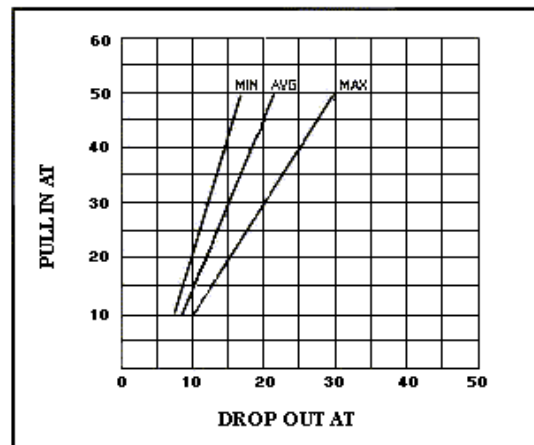

Pull-In Ampere Turns Plotted  
Against Drop-Out Ampere Turns

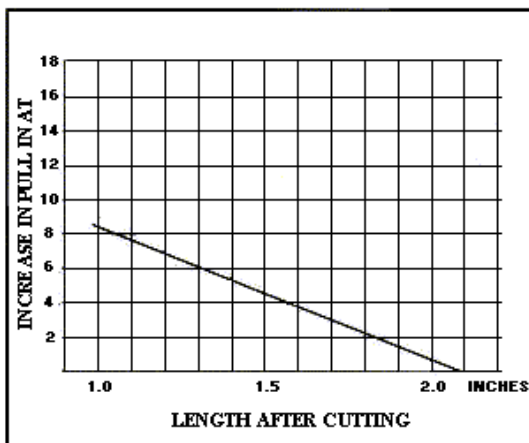

Change In Pull-In Ampere Turns  
After Switch Lead Cutting

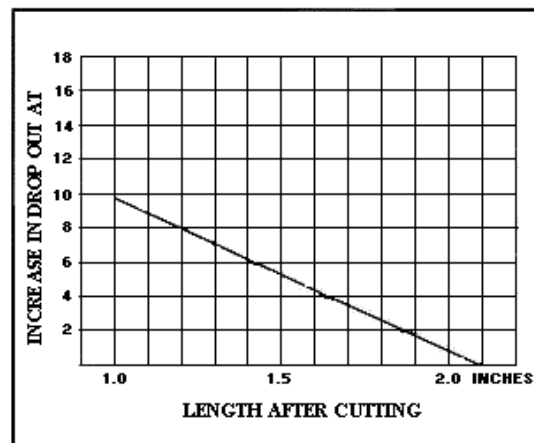

Change In Drop-Out Ampere Turns  
After Switch Lead Cutting

© **Standex Electronics Inc.**

[www.StandexElectronics.com](http://www.StandexElectronics.com)

Cincinnati, Ohio USA  
Phone +513 871 3777  
Fax +513 871 3779

Tonbridge, United Kingdom  
Phone +44 1732 77 10 23  
Fax +44 1732 77 01 22

Tianjin, China  
Tel: +86 22 86 99 68 81~5  
Fax: +86 22 86 99 68 86

## GP100

- General purpose reed switch with PGM alloy contacts.
- Designed to give superior life switching relatively heavy loads.
- Normal applications include liquid level sensors, security systems, reed relays, proximity sensors and counting devices.
- Ideally suited to handle normal 120 VAC loads.
- High stability contact resistance.

### Physical Characteristics:

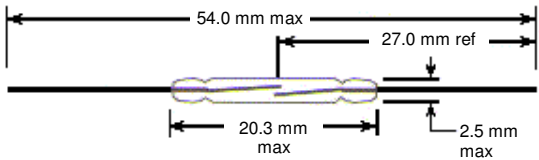
	
Glass Diameter (Max.)	2.5mm
Glass Length (Max.)	20.3mm
Lead Dia. (Nominal)	0.6 mm
Overall Length (Max.)	54.0 mm

### Electrical Characteristics:

Contact Arrangement	Form A (SPST), Centre Gap
Contact Material	PGM alloy
Power Rating <sup>1</sup>	10VA maximum
Switching Current (Max.)	1.0 Amp. DC, 1.0 Amp. AC
Carry Current (Max.)	1.5 Amp. DC, 1.5 Amp. AC
Switching Voltage (Max.) <sup>4</sup>	100 VDC, 150 VAC
Breakdown Voltage (Min. @20AT) <sup>2</sup>	250 Volts DC
Contact Resistance <sup>3</sup>	100 Milliohms
Insulation Resistance (Min.)	10 <sup>12</sup> ohms
Contact Capacitance (pf Max.)	0.2 pf

1. The specification for VA rating may sometimes be exceeded for less sensitive (higher AT) switches, and should be decreased for very sensitive (lower AT) switches. Standex Electronics will run life tests specific to a customers load upon request.
2. Breakdown voltage is measured in the presence of an ionising source. Switch leakage current is limited to 100 microamperes.
3. Contact resistance measurements are made at 10ma from a 1-volt source, with 50% overdrive, using a 4-wire (Kelvin) measuring system. Contact probes are located on 43 mm centres.
4. When switching 150 VAC please contact a Standex application engineer.

### Minimum Switching Life with Standard Test Loads, using 20AT switch:

Voltage	5 VDC	10 VDC	12 VDC	24 VDC	100 VDC	125 VAC	150 VAC
Current	2 mA	1 A	10 mA	10 mA	100 mA	80 mA	60 mA
Life	1000 x 10 <sup>6</sup>	2 x 10 <sup>6</sup>	100 x 10 <sup>6</sup>	8 x 10 <sup>6</sup>	2 x 10 <sup>6</sup>	2 x 10 <sup>6</sup>	1 x 10 <sup>6</sup>

Note: End of life is defined as contact resistance exceeding one ohm and/or failure to operate.

© Standex Electronics Inc.

[www.StandexElectronics.com](http://www.StandexElectronics.com)



## Operating Characteristics

Magnetic Sensitivity (Range - Pull In)	10 to 60 Ampere Turns
Magnetic Sensitivity (Range – Drop Out)	(See chart below)
Operate Time, including bounce (typ.)	0.8 Milliseconds
Release Time (typ.)	0.1 Milliseconds
Resonant Frequency (typ.)	2.2 kHz
Vibration, 10-2,000 Hz (G's Max.)	40 G
Shock, 11-ms. 1/2 Sine wave (G's Max.)	100 G
Operating Temperature	-40°C to + 125°C
Storage Temperature	-50°C to + 155°C

### Charts:

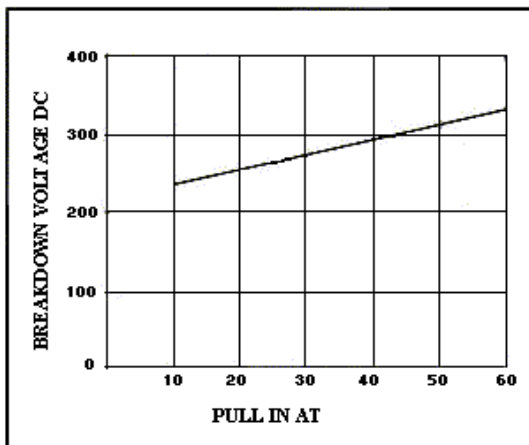

Breakdown Voltage Plotted Against Pull-In Ampere Turns

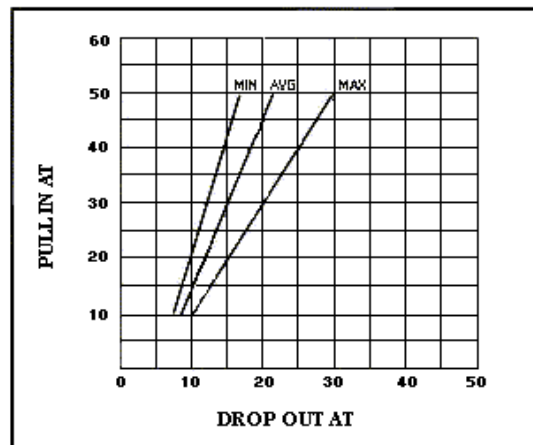

Pull-In Ampere Turns Plotted Against Drop-Out Ampere Turns

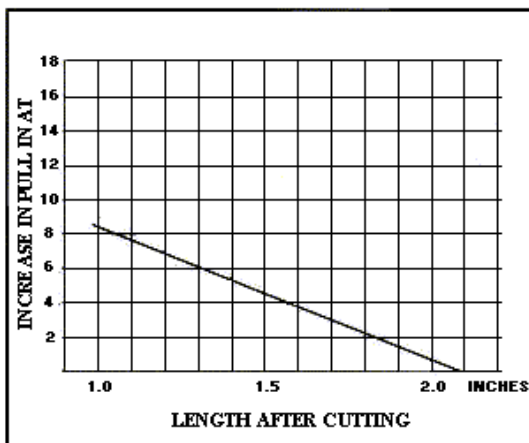

Change In Pull-In Ampere Turns After Switch Lead Cutting

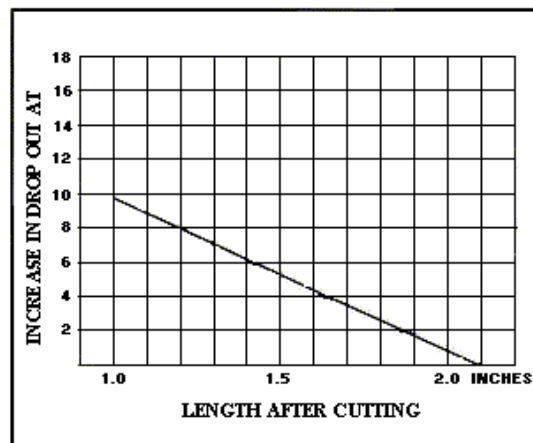

Change In Drop-Out Ampere Turns After Switch Lead Cutting

© **Standex Electronics Inc.**

[www.StandexElectronics.com](http://www.StandexElectronics.com)

Cincinnati, Ohio USA  
Phone +513 871 3777  
Fax +513 871 3779

Tonbridge, United Kingdom  
Phone +44 1732 77 10 23  
Fax +44 1732 77 01 22

Tianjin, China  
Tel: +86 22 86 99 68 81~5  
Fax: +86 22 86 99 68 86

## NL126

- General-purpose miniature reed switch with rhodium contacts.
- Designed to give superior life switching relatively heavy loads.
- Normal applications include test equipment, instrumentation, liquid level sensing and incandescent lamp switching.

### Physical Characteristics:

Glass Diameter (Max.)	2.5 mm
Glass Length (Max.)	20.3 mm
Lead Dia. (Nominal)	0.7 mm
Overall Length (Max.)	54.0 mm

### Electrical Characteristics:

Contact Arrangement	Form A (SPST), Centre Gap
Contact Material	Rhodium
Power Rating <sup>1</sup>	50VA maximum
Switching Current (Max.)	1.5 Amp. DC, 1.5 Amp. AC
Carry Current (Max.)	2.5 Amp. DC, 2.5 Amp. AC
Switching Voltage (Max.) <sup>4</sup>	200 VDC, 150 VAC
Breakdown Voltage (Min. @20AT) <sup>2</sup>	250 Volts DC
Contact Resistance <sup>3</sup>	100 Milliohms
Insulation Resistance (Min.)	10 <sup>12</sup> ohms
Contact Capacitance (pf Max.)	0.3 pf
<ol style="list-style-type: none"> <li>1. The specification for VA rating may sometimes be exceeded for less sensitive (higher AT) switches, and should be decreased for very sensitive (lower AT) switches. Standex Electronics will run life tests specific to a customers load upon request.</li> <li>2. Breakdown voltage is measured in the presence of an ionising source. Switch leakage current is limited to 100 microamperes.</li> <li>3. Contact resistance measurements are made at 10ma from a 1-volt source, with 50% overdrive, using a 4-wire (Kelvin) measuring system. Contact probes are located on 43 mm centres.</li> <li>4. When switching 150 VAC please contact a Standex application engineer.</li> </ol>	

### Minimum Switching Life with Standard Test Loads, using 20AT switch:

Voltage	5 VDC	10 VDC	12 VDC	12 VDC	24 VDC	50 VDC	100 VAC	150 VAC
Current	2 mA	1 A	10 mA	3 A	10 mA	1 A	100 mA	200 mA
Life	1 x 10 <sup>9</sup>	3 x 10 <sup>6</sup>	500 x 10 <sup>6</sup>	50 x 10 <sup>3</sup>	10 x 10 <sup>6</sup>	3 x 10 <sup>6</sup>	3 x 10 <sup>6</sup>	0.5 x 10 <sup>6</sup>
Note: End of life is defined as contact resistance exceeding one ohm and/or failure to operate.								

## Operating Characteristics

Magnetic Sensitivity (Range - Pull In)	20 to 60 Ampere Turns
Magnetic Sensitivity (Range – Drop Out)	(See chart below)
Operate Time, including bounce (typ.)	0.8 Milliseconds
Release Time (typ.)	0.1 Milliseconds
Resonant Frequency (typ.)	2.2 kHz
Vibration, 10-2,000 Hz (G's Max.)	30 G
Shock, 11-ms. 1/2 Sine wave (G's Max.)	100 G
Operating Temperature	-40°C to + 125°C
Storage Temperature	-50°C to + 155°C

### Charts:

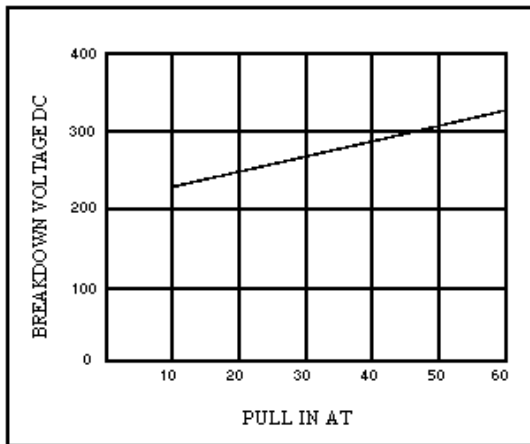

Breakdown Voltage Plotted Against Pull-In Ampere Turns

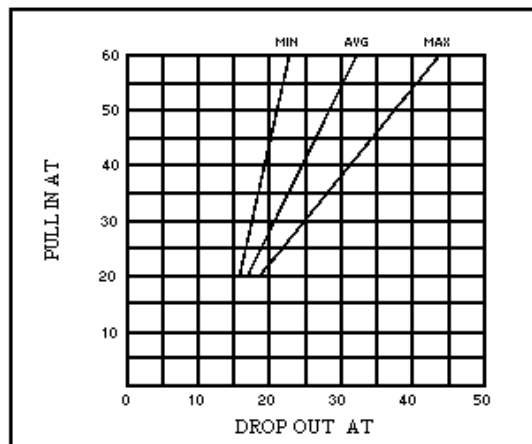

Pull-In Ampere Turns Plotted Against Drop-Out Ampere Turns

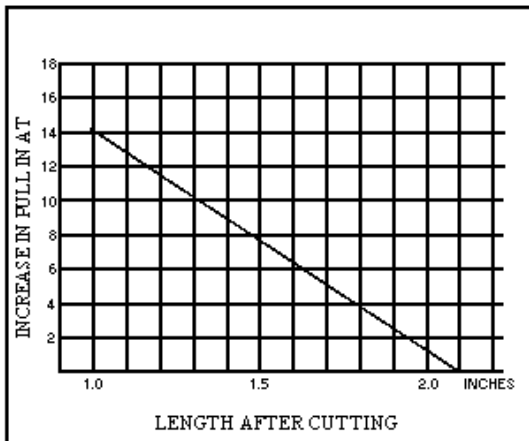

Change In Pull-In Ampere Turns After Switch Lead Cutting

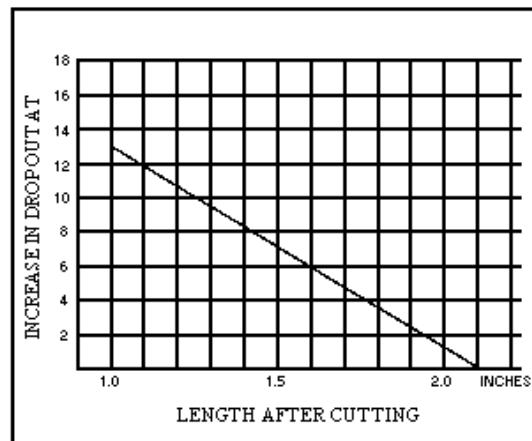

Change In Drop-Out Ampere Turns After Switch Lead Cutting

© **Standex Electronics Inc.**

[www.StandexElectronics.com](http://www.StandexElectronics.com)

Cincinnati, Ohio USA  
Phone +513 871 3777  
Fax +513 871 3779

Tonbridge, United Kingdom  
Phone +44 1732 77 10 23  
Fax +44 1732 77 01 22

Tianjin, China  
Tel: +86 22 86 99 68 81~5  
Fax: +86 22 86 99 68 86

## PR560

- High voltage medium power applications reed switch with rhodium contacts
- Designed to give superior life switching relatively heavy loads

### Physical Characteristics:

Glass Diameter (Max.)	2.3mm
Glass Length (Max.)	14.2mm
Lead Dia. (Nominal)	0.6 mm
Overall Length (Max.)	54.0 mm

### Electrical Characteristics:

Contact Arrangement	Form A (SPST), Centre Gap
Contact Material	Rhodium
Power Rating <sup>1</sup>	10VA maximum
Switching Current (Max.)	1.0 Amp. DC, 1.0 Amp. AC
Carry Current (Max.)	1.5 Amp. DC, 1.5 Amp. AC
Switching Voltage (Max.)	100 VDC, 250 VAC
Breakdown Voltage (Min. @20AT) <sup>2</sup>	600 Volts DC
Contact Resistance <sup>3</sup>	100 Milliohms
Insulation Resistance (Min.)	10 <sup>12</sup> ohms
Contact Capacitance (pf Max.)	0.2 pf

1) The specification for VA rating may sometimes be exceeded for less sensitive (higher AT) switches, and should be decreased for very sensitive (lower AT) switches. Standex Electronics will run life tests specific to a customers load upon request.

2) Breakdown voltage is measured in the presence of an ionising source. Switch leakage current is limited to 100 microamperes.

3) Contact resistance measurements are made at 10ma from a 1-volt source, with 50% overdrive, using a 4-wire (Kelvin) measuring system. Contact probes are located on 43 mm centres.

### Minimum Switching Life with Standard Test Loads, using 20AT switch:

Voltage	12 VDC	24 VDC	100 VDC	125 VAC	240 VDC	240 VAC
Current	10 mA	10 mA	100 mA	80 mA	10 mA	40 mA
Life	100 x 10 <sup>6</sup>	5 x 10 <sup>6</sup>	1 x 10 <sup>6</sup>	1 x 10 <sup>6</sup>	2 x 10 <sup>5</sup>	5 x 10 <sup>5</sup>

Note: End of life is defined as contact resistance exceeding one ohm and/or failure to operate.

## Operating Characteristics:

Magnetic Sensitivity (Range - Pull In)	20 to 40 Ampere Turns
Magnetic Sensitivity (Range – Drop Out)	(See chart below)
Operate Time, including bounce (typ.)	0.6 Milliseconds
Release Time (typ.)	0.1 Milliseconds
Resonant Frequency (typ.)	3.0 kHz
Vibration, 10-2,000 Hz (G's Max.)	50 G
Shock, 11-ms. ½ Sine wave (G's Max.)	100 G
Operating Temperature	-40°C to + 125°C
Storage Temperature	-50°C to + 155°C

## Charts:

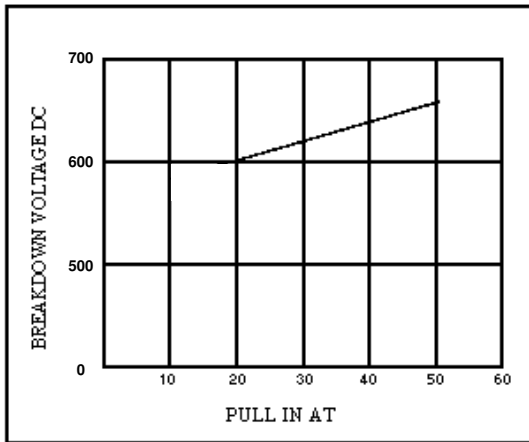

Breakdown Voltage Plotted  
Against Pull-In Ampere Turns

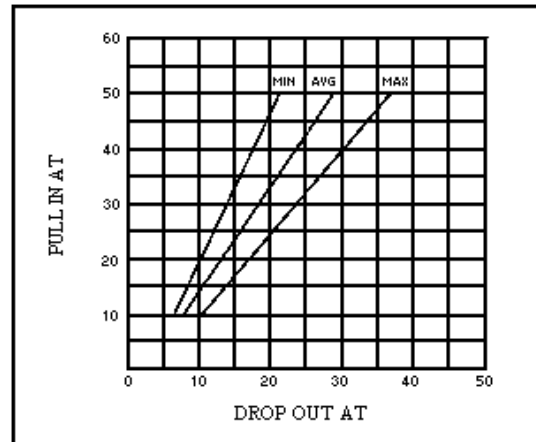

Pull-In Ampere Turns Plotted  
Against Drop-Out Ampere Turns

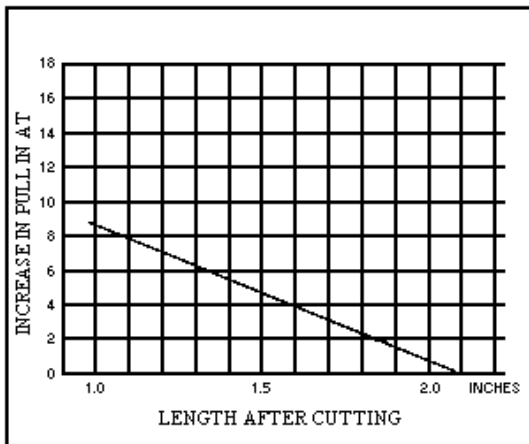

Change In Pull-In Ampere Turns  
After Switch Lead Cutting

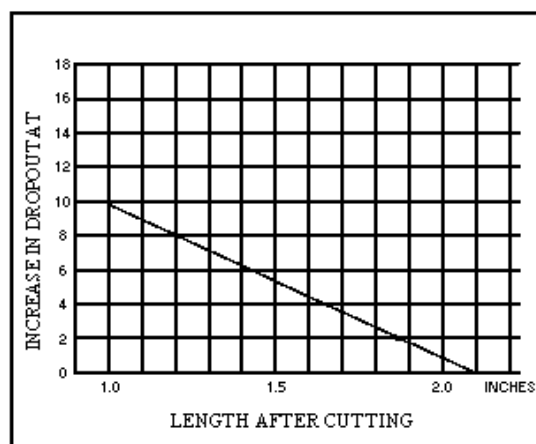

Change In Drop-Out Ampere Turns  
After Switch Lead Cutting

© **Standex Electronics Inc.**

**www.StandexElectronics.com**

Cincinnati, Ohio USA  
Phone +513 871 3777  
Fax +513 871 3779

Tonbridge, United Kingdom  
Phone +44 1732 77 10 23  
Fax +44 1732 77 01 22

Tianjin, China  
Tel: +86 22 86 99 68 81~5  
Fax: +86 22 86 99 68 86

## PR126

- High voltage high power applications reed switch with rhodium contacts
- Designed to give superior life switching relatively heavy loads

### Physical Characteristics:

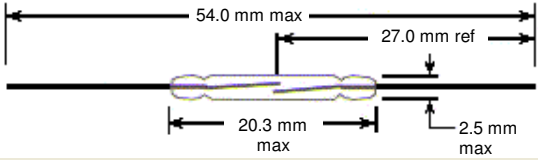

Glass Diameter (Max.)	2.5 mm
Glass Length (Max.)	20.3 mm
Lead Dia. (Nominal)	0.7 mm
Overall Length (Max.)	54.0 mm

### Electrical Characteristics:

Contact Arrangement	Form A (SPST), Centre Gap
Contact Material	Rhodium
Power Rating <sup>1</sup>	70VA maximum
Switching Current (Max.)	1.5 Amp. DC, 1.5 Amp. AC
Carry Current (Max.)	2.5 Amp. DC, 2.5 Amp. AC
Switching Voltage (Max.)	200 VDC, 300 VAC
Breakdown Voltage (Min. @20AT) <sup>2</sup>	750 Volts DC
Contact Resistance <sup>3</sup>	100 Milliohms
Insulation Resistance (Min.)	10 <sup>12</sup> ohms
Contact Capacitance (pf Max.)	0.3 pf
<p>1) The specification for VA rating may sometimes be exceeded for less sensitive (higher AT) switches, and should be decreased for very sensitive (lower AT) switches. Standex Electronics will run life tests specific to a customers load upon request.</p> <p>2) Breakdown voltage is measured in the presence of an ionising source. Switch leakage current is limited to 100 microamperes.</p> <p>3) Contact resistance measurements are made at 10ma from a 1-volt source, with 50% overdrive, using a 4-wire (Kelvin) measuring system. Contact probes are located on 43mm centres.</p>	

### Minimum Switching Life with Standard Test Loads, using 20AT switch:

Voltage	24 VDC	100 VDC	125 VAC	240 VDC	240 VAC
Current	10 mA	100 mA	80 mA	40 mA	40 VA lamp load, 5 sec period, 10% duty cycle
Life	5 x 10 <sup>6</sup>	1 x 10 <sup>6</sup>	1 x 10 <sup>6</sup>	2 x 10 <sup>5</sup>	5 x 10 <sup>5</sup>
Note: End of life is defined as contact resistance exceeding one ohm and/or failure to operate.					

## Operating Characteristics:

Magnetic Sensitivity (Range - Pull In)	20 to 50 Ampere Turns
Magnetic Sensitivity (Range – Drop Out)	(See chart below)
Operate Time, including bounce (typ.)	0.8 Milliseconds
Release Time (typ.)	0.1 Milliseconds
Resonant Frequency (typ.)	2.2 kHz
Vibration, 10-2,000 Hz (G's Max.)	30 G
Shock, 11-ms. 1/2 Sine wave (G's Max.)	100 G
Operating Temperature	-40°C to + 125°C
Storage Temperature	-50°C to + 155°C

## Charts:

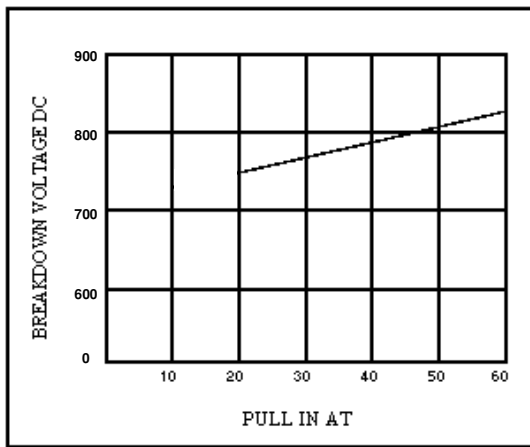

Breakdown Voltage Plotted  
Against Pull-In Ampere Turns

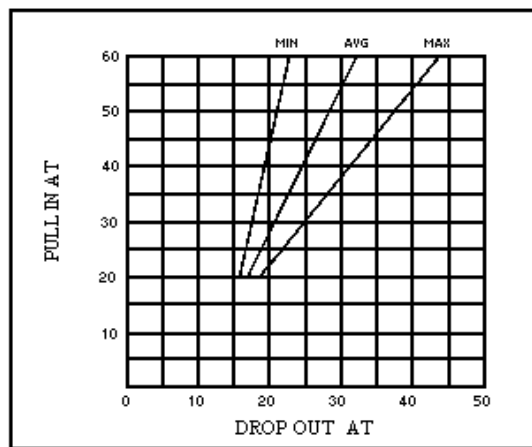

Pull-In Ampere Turns Plotted  
Against Drop-Out Ampere Turns

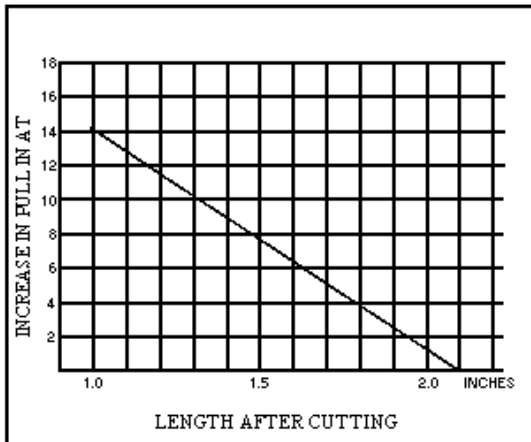

Change In Pull-In Ampere Turns  
After Switch Lead Cutting

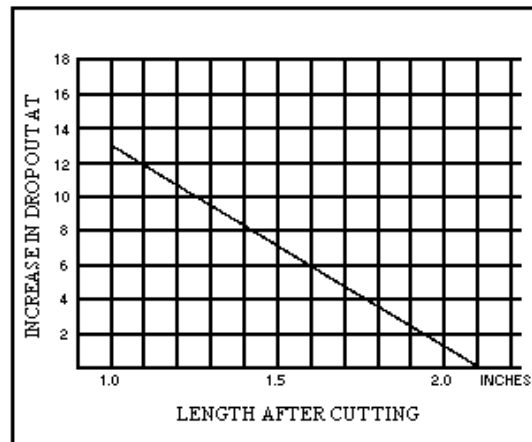

Change In Drop-Out Ampere Turns  
After Switch Lead Cutting

© **Standex Electronics Inc.**

[www.StandexElectronics.com](http://www.StandexElectronics.com)

Cincinnati, Ohio USA  
Phone +513 871 3777  
Fax +513 871 3779

Tonbridge, United Kingdom  
Phone +44 1732 77 10 23  
Fax +44 1732 77 01 22

Tianjin, China  
Tel: +86 22 86 99 68 81~5  
Fax: +86 22 86 99 68 86

## Custom lead forming and customer specific requirements

Standex can accommodate custom lead forming and/or cropping including surface mount options supplied in tape and reel or loose. Surface mount options can be over moulded or a bare reed switch with a custom formed lead, see following drawing for dimensions. We can supply various over moulded switch types and we can weld longer terminals depending on customer specific requirements upon request:

High volume requirements of any of the above are easily accommodated.

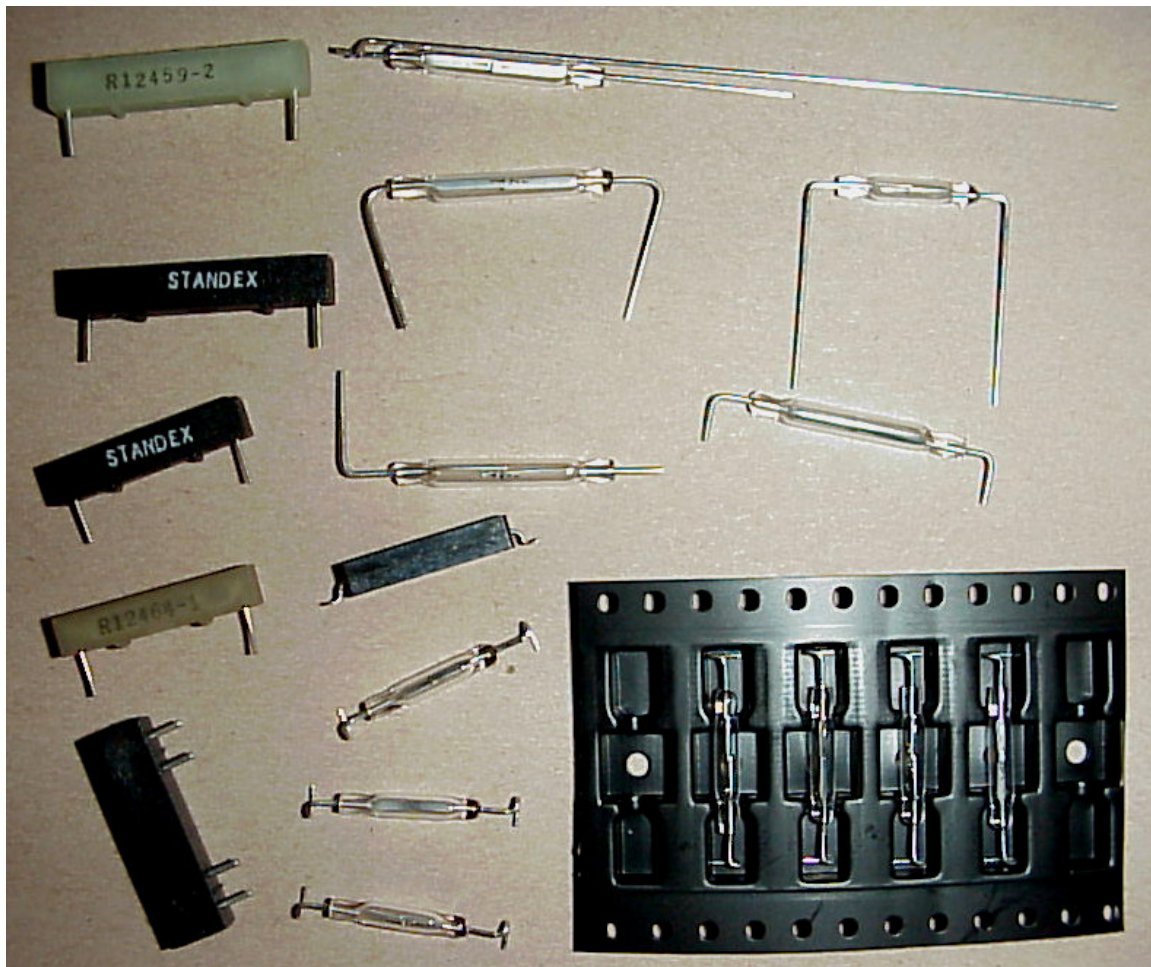

Custom lead forming and encapsulated reed switches



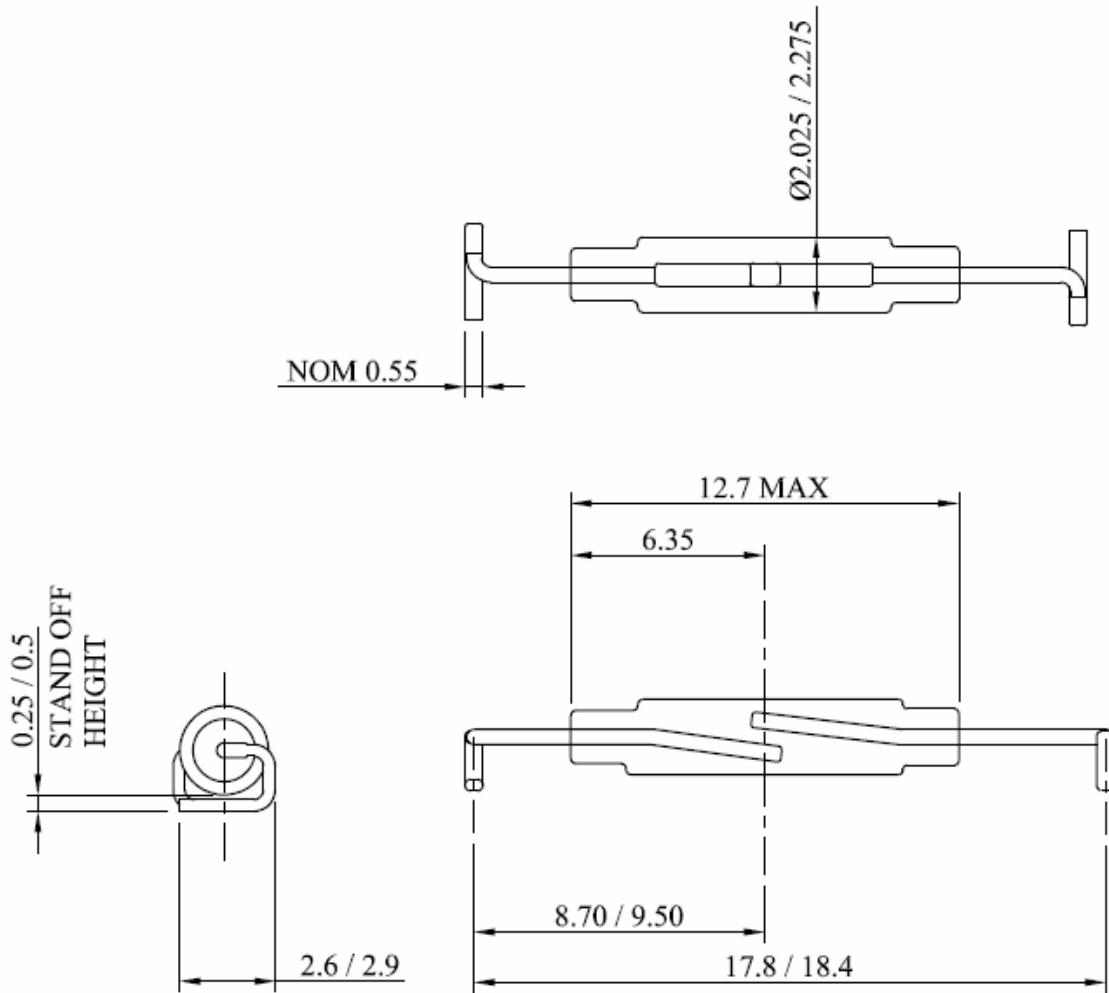

Bare glass surface mount reed switch dimensions using a 501 base switch variant, available in tape and reel or loose packed.

## Commercial grade reed switch quick selection chart:

All Standex switches are UL recognised and RoHS compliant.

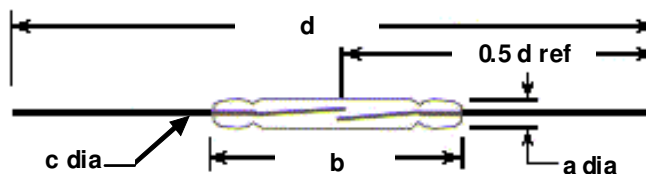

Switch type	TS501	TR501	TS560	TR560	TS100	TR100
<b>Physical Characteristics</b>						
Glass dia (max) - a	2.3mm	2.3mm	2.3mm	2.3mm	2.5mm	2.5mm
Glass length max - b	12.7mm	12.7mm	14.2mm	14.2mm	21.0mm	21.0mm
Lead dia nominal - c	0.45mm	0.45mm	0.6mm	0.6mm	0.7mm	0.7mm
Overall length - d	54.0mm	54.0mm	54.0mm	54.0mm	54.0mm	54.0mm
<b>Electrical Characteristics</b>						
Contact material	Noble metal	Noble metal	Noble metal	Noble metal	Noble metal	Noble metal
Power rating maximum	7 VA	10 VA	8 VA	10 VA	8 VA	10 VA
Switching current maximum	0.3 Amp DC & AC	0.5 Amp DC & AC	0.5 Amp DC & AC	1.0 Amp DC & AC	0.5 Amp DC & AC	1.0 Amp DC & AC
Carry current maximum	0.5 Amp DC & AC	0.8 Amp DC & AC	1.0 Amp DC & AC	1.5 Amp DC & AC	1.0 Amp DC & AC	1.5 Amp DC & AC
Switching voltage maximum	50 VDC 75 VAC	100 VDC 125 VAC	75 VDC 100 VAC	100 VDC 125 VAC	100 VAC 125 VDC	100 VAC 150 VDC
Breakdown volt minimum @20AT	150 Volts DC	200 Volts DC	150 Volts DC	200 Volts DC	200 Volts DC	250 Volts DC
Contact resistance	250 mΩ	200 mΩ	250 mΩ	200 mΩ	250 mΩ	200 mΩ
Insulation resistance minimum	10 <sup>9</sup> Ω	10 <sup>12</sup> Ω	10 <sup>9</sup> Ω	10 <sup>12</sup> Ω	10 <sup>9</sup> Ω	10 <sup>12</sup> Ω
Contact capacitance pf maximum	0.3 pF	0.3 pF	0.2 pF	0.2 pF	0.2 pF	0.2 pF
<b>Operating Characteristics</b>						
Magnetic sensitivity (range - pull in)	10 to 30 AT	7 to 30 AT	10 to 35 AT	10 to 50 AT	10 to 35 AT	10 to 35 AT
Operate time, inc. bounce typical	1.5 msec	1.0 msec	1.0 msec	0.6 msec	1.0 msec	0.8 msec
Release time typical	0.1 msec	0.1 msec	0.1 msec	0.1 msec	0.1 msec	0.1 msec
Resonant Frequency	3.2 kHz	3.2 kHz	3.0 kHz	3.0 kHz	2.2 kHz	2.2 kHz
Vibration, 10-2000Hz maximum	30 G	50 G	30 G	50 G	30 G	40 G
Shock, 11-ms. ½ sine wave maximum	100 G	100 G	100 G	100 G	100 G	100 G
Operating temperature	-40°C to +125°C	-40°C to +125°C	-40°C to +125°C	-40°C to +125°C	-40°C to +125°C	-40°C to +125°C
Storage temperature	-50°C to +155°C	-50°C to +155°C	-50°C to +155°C	-50°C to +155°C	-50°C to +155°C	-50°C to +155°C

## TS501

- Commercial grade reed switch for cost sensitive applications.

### Physical Characteristics:

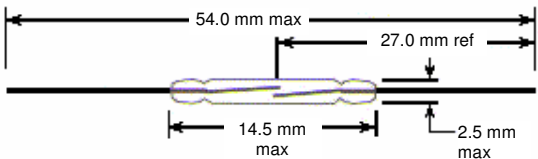

Glass Diameter (Max.)	2.5mm
Glass Length (Max.)	14.5mm
Lead Dia. (Nominal)	0.45mm
Overall Length (Max.)	54.0mm

### Electrical Characteristics:

Contact Arrangement	Form A (SPST), Centre Gap
Contact Material	Noble metal
Power Rating <sup>1</sup>	7 VA maximum
Switching Current (Max.)	0.3 Amp. DC, 0.3 Amp. AC
Carry Current (Max.)	0.5 Amp. DC, 0.5 Amp. AC
Switching Voltage (Max.)	50 VDC, 75 VAC
Breakdown Voltage (Min. @20AT) <sup>2</sup>	150 Volts DC
Contact Resistance <sup>3</sup>	250 Milliohms
Insulation Resistance (Min.)	10 <sup>9</sup> ohms
Contact Capacitance (pf Max.)	0.3 pf

- The specification for VA rating may sometimes be exceeded for less sensitive (higher AT) switches, and should be decreased for very sensitive (lower AT) switches. Standex Electronics will run life tests specific to a customers load upon request.
- Breakdown voltage is measured in the presence of an ionising source. Switch leakage current is limited to 100 microamperes.
- Contact resistance measurements are made at 10ma from a 1-volt source, with 50% overdrive, using a 4-wire (Kelvin) measuring system. Contact probes are located on 43 mm centres.

### Minimum Switching Life with Standard Test Loads, using 20AT switch:

Voltage	12 VDC	75 VDC
Current	10 mA	100 mA
Life	> 2 million	> 1 million

Note: End of life is defined as contact resistance exceeding one ohm and/or failure to operate.

## Operating Characteristics:

Magnetic Sensitivity (Range - Pull In)	10 to 30 Ampere Turns
Magnetic Sensitivity (Range – Drop Out)	20 to 98% of Pull-In
Operate Time, including bounce (typ.)	1.5 Milliseconds
Release Time (typ.)	0.1 Milliseconds
Resonant Frequency (typ.)	3.2 kHz
Vibration, 10-2,000 Hz (G's Max.)	30 G
Shock, 11-ms. ½ Sine wave (G's Max.)	100 G
Operating Temperature	-40°C to + 125°C
Storage Temperature	-50°C to + 155°C

## Charts:

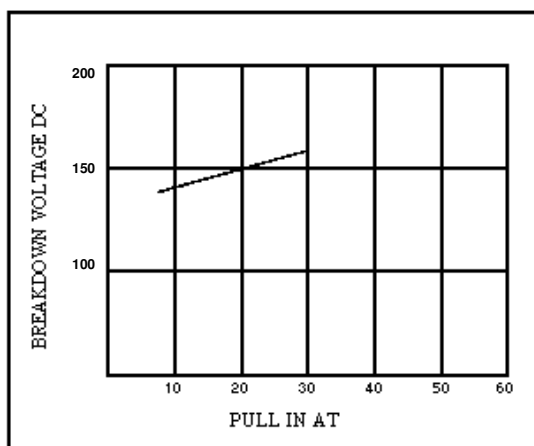

Breakdown Voltage Plotted Against Pull-In Ampere Turns

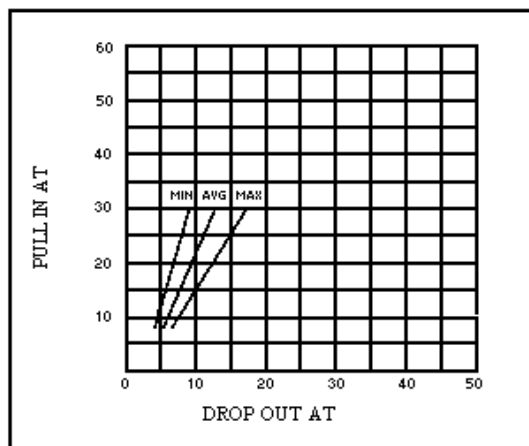

Pull-In Ampere Turns Plotted Against Drop-Out Ampere Turns

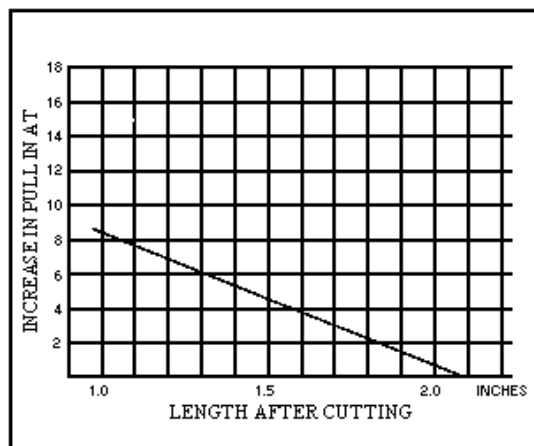

Change In Pull-In Ampere Turns After Switch Lead Cutting

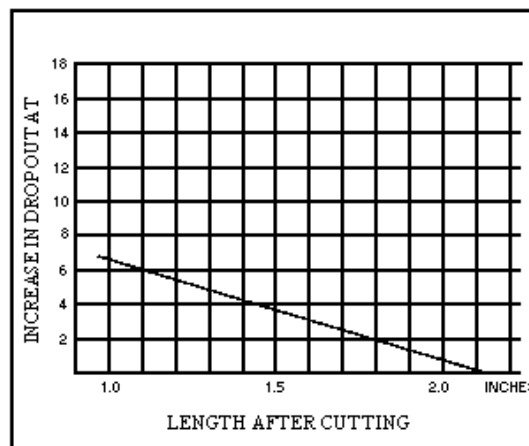

Change In Drop-Out Ampere Turns After Switch Lead Cutting

© **Standex Electronics Inc.**

[www.StandexElectronics.com](http://www.StandexElectronics.com)

Cincinnati, Ohio USA  
Phone +513 871 3777  
Fax +513 871 3779

Tonbridge, United Kingdom  
Phone +44 1732 77 10 23  
Fax +44 1732 77 01 22

Tianjin, China  
Tel: +86 22 86 99 68 81~5  
Fax: +86 22 86 99 68 86

## TR501

- Commercial grade general-purpose miniature reed switch.

### Physical Characteristics:

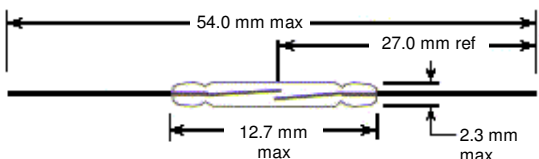

Glass Diameter (Max.)	2.3mm
Glass Length (Max.)	12.7mm
Lead Dia. (Nominal)	0.45 mm
Overall Length (Max.)	54.0 mm

### Electrical Characteristics:

Contact Arrangement	Form A (SPST), Centre Gap
Contact Material	Noble metal
Power Rating <sup>1</sup>	10VA maximum
Switching Current (Max.)	0.5 Amp. DC, 0.5 Amp. AC
Carry Current (Max.)	0.8 Amp. DC, 0.8 Amp. AC
Switching Voltage (Max.)	100 VDC, 125 VAC
Breakdown Voltage (Min. @20AT) <sup>2</sup>	200 Volts DC
Contact Resistance <sup>3</sup>	200 Milliohms
Insulation Resistance (Min.)	10 <sup>12</sup> ohms
Contact Capacitance (pf Max.)	0.3 pf

- The specification for VA rating may sometimes be exceeded for less sensitive (higher AT) switches, and should be decreased for very sensitive (lower AT) switches. Standex Electronics will run life tests specific to a customers load upon request.
- Breakdown voltage is measured in the presence of an ionising source. Switch leakage current is limited to 100 microamperes
- Contact resistance measurements are made at 10ma from a 1-volt source, with 50% overdrive, using a 4-wire (Kelvin) measuring system. Contact probes are located on 43 mm centres.

### Minimum Switching Life with Standard Test Loads, using 20AT switch;

Voltage	5 VDC	10 VDC	12 VDC	24 VDC	100 VDC	125 VAC
Current	2 mA	1 A	10 mA	10 mA	100 mA	80 mA
Life	50 x 10 <sup>6</sup>	0.25 x 10 <sup>6</sup>	5 x 10 <sup>6</sup>	1 x 10 <sup>6</sup>	0.25 x 10 <sup>6</sup>	0.25 x 10 <sup>6</sup>

Note: End of life is defined as contact resistance exceeding one ohm and/or failure to operate.

## Operating Characteristics:

Magnetic Sensitivity (Range - Pull In)	7 to 30 Ampere Turns
Magnetic Sensitivity (Range - Drop Out)	(See chart below)
Operate Time, including bounce (typ.)	1.0 Milliseconds
Release Time (typ.)	0.1 Milliseconds
Resonant Frequency (typ.)	3.2 kHz
Vibration, 10-2,000 Hz (G's Max.)	50 G
Shock, 11-ms. 1/2 Sine wave (G's Max.)	100 G
Operating Temperature	-40°C to + 125°C
Storage Temperature	-50°C to + 155°C

## Charts:

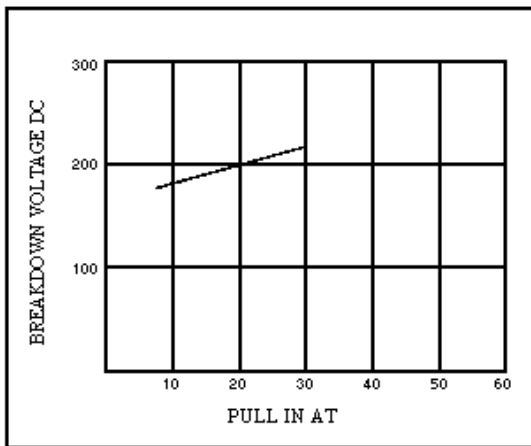

Breakdown Voltage Plotted Against Pull-In Ampere Turns

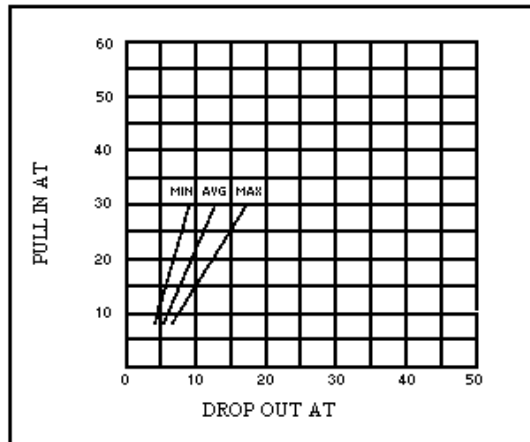

Pull-In Ampere Turns Plotted Against Drop-Out Ampere Turns

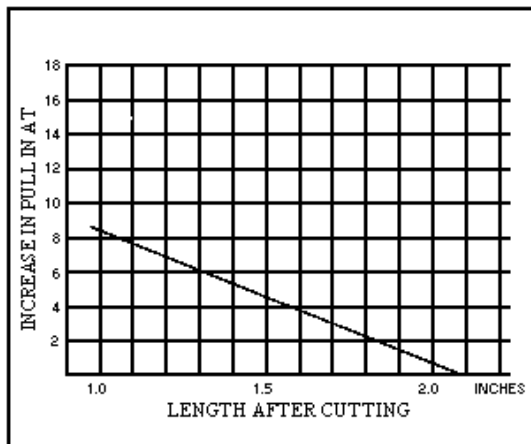

Change In Pull-In Ampere Turns After Switch Lead Cutting

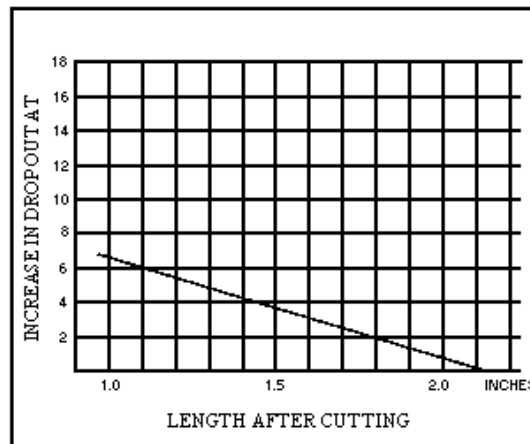

Change In Drop-Out Ampere Turns After Switch Lead Cutting

© **Standex Electronics Inc.**

**www.StandexElectronics.com**

Cincinnati, Ohio USA  
Phone +513 871 3777  
Fax +513 871 3779

Tonbridge, United Kingdom  
Phone +44 1732 77 10 23  
Fax +44 1732 77 01 22

Tianjin, China  
Tel: +86 22 86 99 68 81~5  
Fax: +86 22 86 99 68 86

## TS560

- Commercial grade reed switch for cost sensitive applications

### Physical Characteristics:

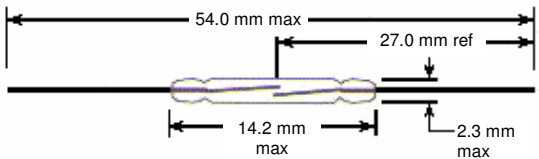

Glass Diameter (Max.)	2.3mm
Glass Length (Max.)	14.2mm
Lead Dia. (Nominal)	0.6 mm
Overall Length (Max.)	54.0 mm

### Electrical Characteristics:

Contact Arrangement	Form A (SPST), Centre Gap
Contact Material	Noble Metal
Power Rating <sup>1</sup>	8VA maximum
Switching Current (Max.)	0.5 Amp. DC, 0.5 Amp. AC
Carry Current (Max.)	1.0 Amp. DC, 1.0 Amp. AC
Switching Voltage (Max.)	75 VDC, 100 VAC
Breakdown Voltage (Min. @20AT) <sup>2</sup>	150 Volts DC
Contact Resistance <sup>3</sup>	250 Milliohms
Insulation Resistance (Min.)	10 <sup>9</sup> ohms
Contact Capacitance (pf Max.)	0.2 pf

- The specification for VA rating may sometimes be exceeded for less sensitive (higher AT) switches, and should be decreased for very sensitive (lower AT) switches. Standex Electronics will run life tests specific to a customers load upon request.
- Breakdown voltage is measured in the presence of an ionising source. Switch leakage current is limited to 100 microamperes.
- Contact resistance measurements are made at 10ma from a 1-volt source, with 50% overdrive, using a 4-wire (Kelvin) measuring system. Contact probes are located on 43 mm centres.

### Minimum Switching Life with Standard Test Loads, using 20AT switch:

Voltage	12 VDC	75 VDC
Current	10 mA	100 mA
Life	> 2 million	> 1 million

Note: End of life is defined as contact resistance exceeding one ohm and/or failure to operate.

<b>© Standex Electronics Inc.</b>		<b>www.StandexElectronics.com</b>
Cincinnati, Ohio USA Phone +513 871 3777 Fax +513 871 3779	Tonbridge, United Kingdom Phone +44 1732 77 10 23 Fax +44 1732 77 01 22	Tianjin, China Tel: +86 22 86 99 68 81~5 Fax: +86 22 86 99 68 86

## Operating Characteristics:

Magnetic Sensitivity (Range - Pull In)	10 to 35 Ampere Turns
Magnetic Sensitivity (Range – Drop Out)	20 to 98% of Pull-In
Operate Time, including bounce (typ.)	1.0 Milliseconds
Release Time (typ.)	0.1 Milliseconds
Resonant Frequency (typ.)	3.0 kHz
Vibration, 10-2,000 Hz (G's Max.)	30 G
Shock, 11-ms. ½ Sine wave (G's Max.)	100 G
Operating Temperature	-40°C to + 125°C
Storage Temperature	-50°C to + 155°C

## Charts:

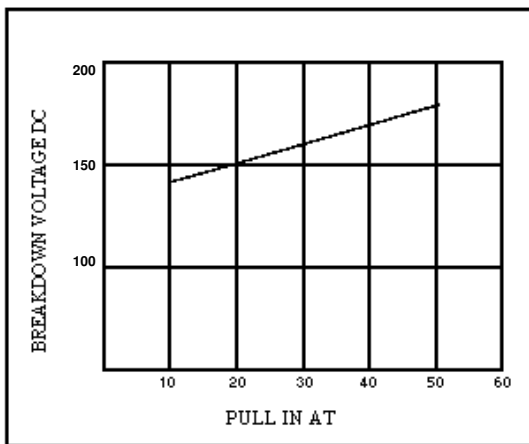

Breakdown Voltage Plotted Against Pull-In Ampere Turns

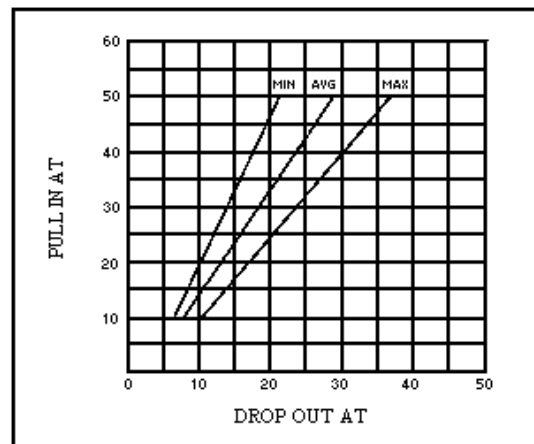

Pull-In Ampere Turns Plotted Against Drop-Out Ampere Turns

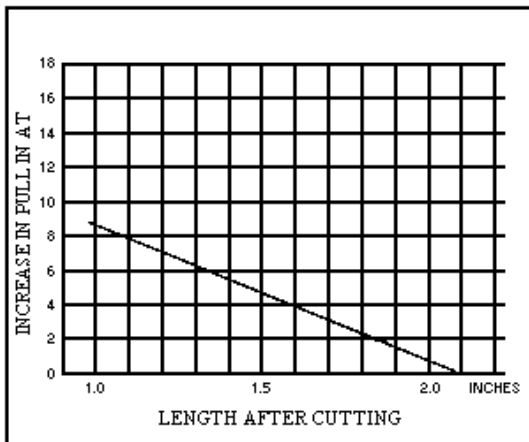

Change In Pull-In Ampere Turns After Switch Lead Cutting

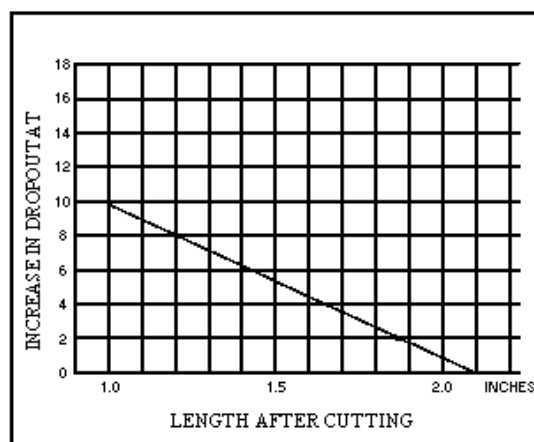

Change In Drop-Out Ampere Turns After Switch Lead Cutting

© <b>Standex Electronics Inc.</b>			<b>www.StandexElectronics.com</b>		
Cincinnati, Ohio USA		Tonbridge, United Kingdom		Tianjin, China	
Phone +513 871 3777		Phone +44 1732 77 10 23		Tel: +86 22 86 99 68 81~5	
Fax +513 871 3779		Fax +44 1732 77 01 22		Fax: +86 22 86 99 68 86	



## TR560

- Commercial grade general-purpose miniature reed switch.

### Physical Characteristics:

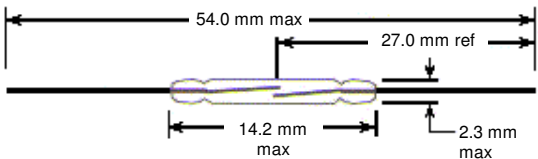

Glass Diameter (Max.)	2.3mm
Glass Length (Max.)	14.2mm
Lead Dia. (Nominal)	0.6 mm
Overall Length (Max.)	54.0 mm

### Electrical Characteristics:

Contact Arrangement	Form A (SPST), Centre Gap
Contact Material	Noble metal
Power Rating <sup>1</sup>	10VA maximum
Switching Current (Max.)	1.0 Amp. DC, 1.0 Amp. AC
Carry Current (Max.)	1.5 Amp. DC, 1.5 Amp. AC
Switching Voltage (Max.)	100 VDC, 125 VAC
Breakdown Voltage (Min. @20AT) <sup>2</sup>	200 Volts DC
Contact Resistance <sup>3</sup>	200 Milliohms
Insulation Resistance (Min.)	10 <sup>12</sup> ohms
Contact Capacitance (pf Max.)	0.2 pf

1. The specification for VA rating may sometimes be exceeded for less sensitive (higher AT) switches, and should be decreased for very sensitive (lower AT) switches. Standex Electronics will run life tests specific to a customers load upon request.

2. Breakdown voltage is measured in the presence of an ionising source. Switch leakage current is limited to 100 microamperes.

3. Contact resistance measurements are made at 10ma from a 1-volt source, with 50% overdrive, using a 4-wire (Kelvin) measuring system. Contact probes are located on 43 mm centres.

### Minimum Switching Life with Standard Test Loads, using 20AT switch:

Voltage	5 VDC	10 VDC	12 VDC	24 VDC	100 VDC	125 VAC
Current	2 mA	1 A	10 mA	10 mA	100 mA	80 mA
Life	50 x 10 <sup>6</sup>	0.5 x 10 <sup>6</sup>	50 x 10 <sup>6</sup>	2.5 x 10 <sup>6</sup>	0.5 x 10 <sup>6</sup>	0.5 x 10 <sup>6</sup>

Note: End of life is defined as contact resistance exceeding one ohm and/or failure to operate.

## Operating Characteristics:

Magnetic Sensitivity (Range - Pull In)	10 to 50 Ampere Turns
Magnetic Sensitivity (Range – Drop Out)	(See chart below)
Operate Time, including bounce (typ.)	0.6 Milliseconds
Release Time (typ.)	0.1 Milliseconds
Resonant Frequency (typ.)	3.0 kHz
Vibration, 10-2,000 Hz (G's Max.)	50 G
Shock, 11-ms. ½ Sine wave (G's Max.)	100 G
Operating Temperature	-40°C to + 125°C
Storage Temperature	-50°C to + 155°C

## Charts:

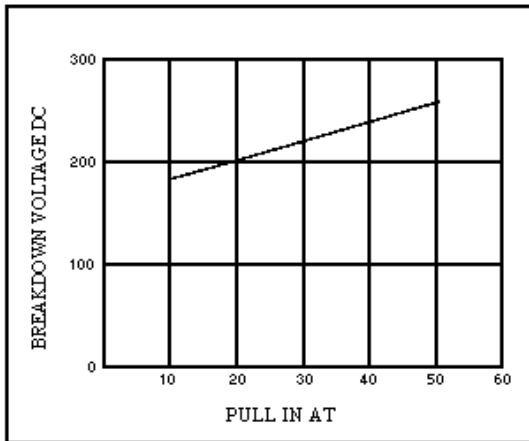

Breakdown Voltage Plotted Against Pull-In Ampere Turns

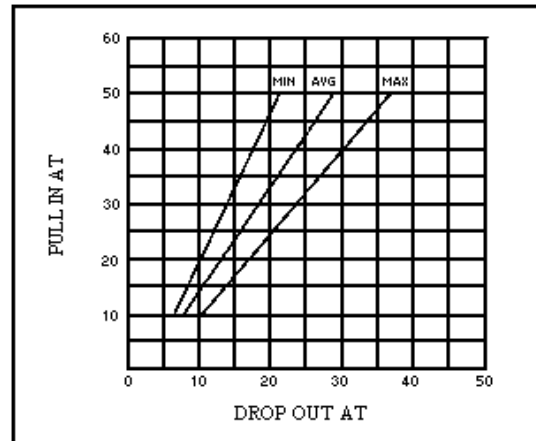

Pull-In Ampere Turns Plotted Against Drop-Out Ampere Turns

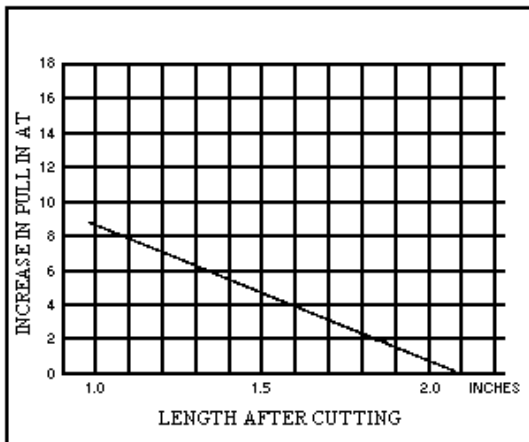

Change In Pull-In Ampere Turns After Switch Lead Cutting

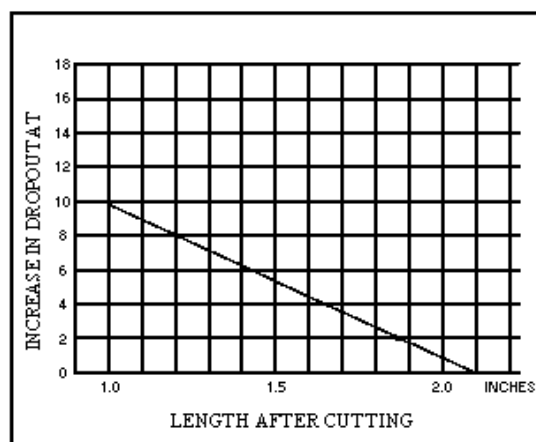

Change In Drop-Out Ampere Turns After Switch Lead Cutting

© <b>Standex Electronics Inc.</b>			<b>www.StandexElectronics.com</b>		
Cincinnati, Ohio USA		Tonbridge, United Kingdom		Tianjin, China	
Phone +513 871 3777		Phone +44 1732 77 10 23		Tel: +86 22 86 99 68 81~5	
Fax +513 871 3779		Fax +44 1732 77 01 22		Fax: +86 22 86 99 68 86	

## TS100

- Commercial grade reed switch for cost sensitive applications.

### Physical Characteristics:

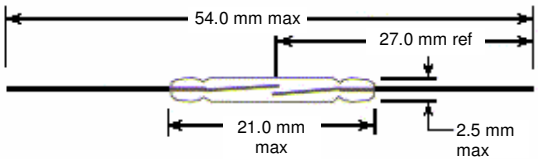

Glass Diameter (Max.)	2.5mm
Glass Length (Max.)	21.0mm
Lead Dia. (Nominal)	0.7 mm
Overall Length (Max.)	54.0 mm

### Electrical Characteristics:

Contact Arrangement	Form A (SPST), Centre Gap
Contact Material	Noble Metal
Power Rating <sup>1</sup>	8VA maximum
Switching Current (Max.)	0.5 Amp. DC, 0.5 Amp. AC
Carry Current (Max.)	1.0 Amp. DC, 1.0 Amp. AC
Switching Voltage (Max.)	100 VDC, 125 VAC
Breakdown Voltage (Min. @20AT) <sup>2</sup>	200 Volts DC
Contact Resistance <sup>3</sup>	250 Milliohms
Insulation Resistance (Min.)	10 <sup>9</sup> ohms
Contact Capacitance (pf Max.)	0.2 pf

- The specification for VA rating may sometimes be exceeded for less sensitive (higher AT) switches, and should be decreased for very sensitive (lower AT) switches.
- Breakdown voltage is measured in the presence of an ionising source. Switch leakage current is limited to 100 microamperes.
- Contact resistance measurements are made at 10ma from a 1-volt source, with 50% overdrive, using a 4-wire (Kelvin) measuring system. Contact probes are located on 43 mm centres.

### Minimum Switching Life with Standard Test Loads, using 20AT switch:

Voltage	12 VDC	100 VDC
Current	10 mA	100 mA
Life	> 2 million	> 1 million

Note: End of life is defined as contact resistance exceeding one ohm and/or failure to operate.

## Operating Characteristics:

Magnetic Sensitivity (Range - Pull In)	10 to 35 Ampere Turns
Magnetic Sensitivity (Range – Drop Out)	20 to 98% of Pull In
Operate Time, including bounce (typ.)	1.0 Milliseconds
Release Time (typ.)	0.1 Milliseconds
Resonant Frequency (typ.)	2.2 kHz
Vibration, 10-2,000 Hz (G's Max.)	30 G
Shock, 11-ms. 1/2 Sine wave (G's Max.)	100 G
Operating Temperature	-40°C to + 125°C
Storage Temperature	-50°C to + 155°C

## Charts:

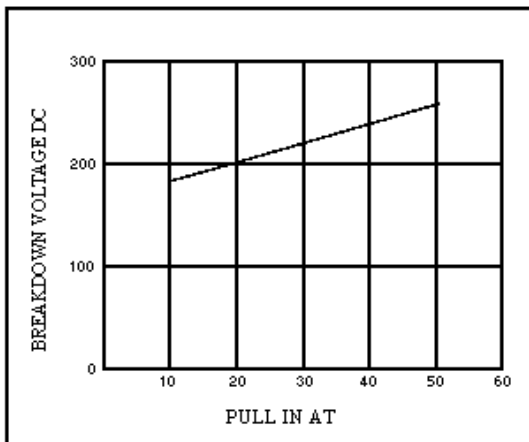

Breakdown Voltage Plotted Against Pull-In Ampere Turns

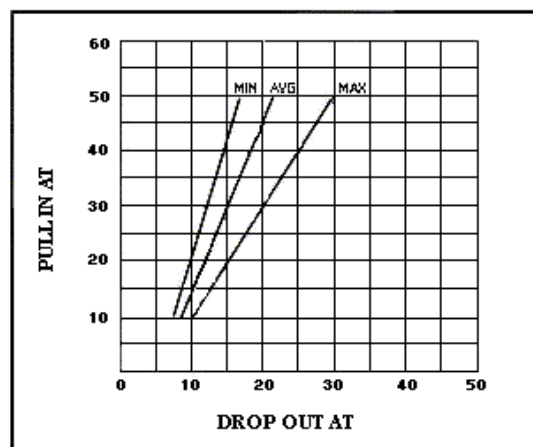

Pull-In Ampere Turns Plotted Against Drop-Out Ampere Turns

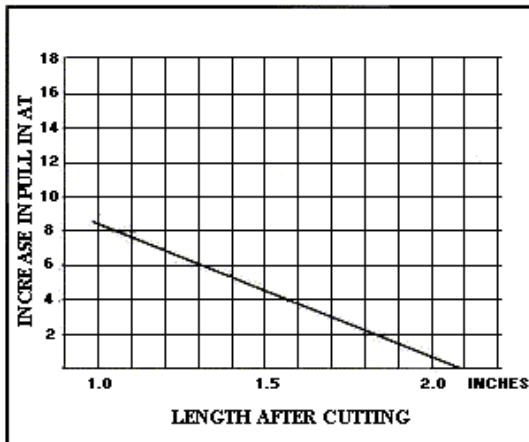

Change In Pull-In Ampere Turns After Switch Lead Cutting

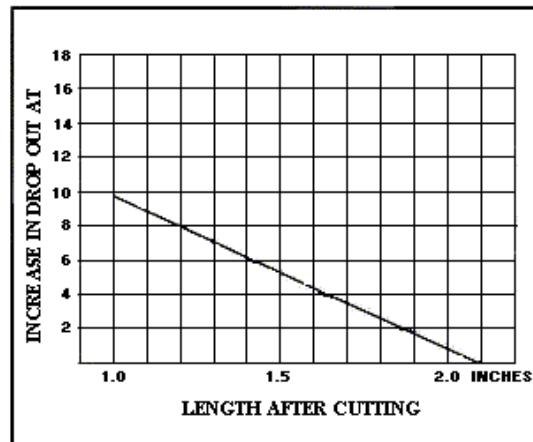

Change In Drop-Out Ampere Turns After Switch Lead Cutting

© **Standex Electronics Inc.**

[www.StandexElectronics.com](http://www.StandexElectronics.com)

Cincinnati, Ohio USA  
Phone +513 871 3777  
Fax +513 871 3779

Tonbridge, United Kingdom  
Phone +44 1732 77 10 23  
Fax +44 1732 77 01 22

Tianjin, China  
Tel: +86 22 86 99 68 81-5  
Fax: +86 22 86 99 68 86

## TR100

- Commercial grade general-purpose miniature reed switch.

### Physical Characteristics:

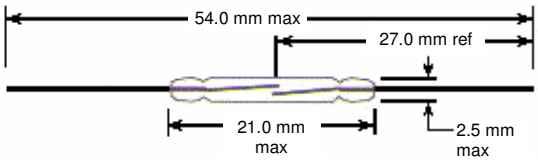

Glass Diameter (Max.)	2.5mm
Glass Length (Max.)	21.0mm
Lead Dia. (Nominal)	0.7 mm
Overall Length (Max.)	54.0 mm

### Electrical Characteristics:

Contact Arrangement	Form A (SPST), Centre Gap
Contact Material	Noble Metal
Power Rating <sup>1</sup>	10VA maximum
Switching Current (Max.)	1.0 Amp. DC, 1.0 Amp. AC
Carry Current (Max.)	1.5 Amp. DC, 1.5 Amp. AC
Switching Voltage (Max.)	100 VDC, 150 VAC
Breakdown Voltage (Min. @20AT) <sup>2</sup>	250 Volts DC
Contact Resistance <sup>3</sup>	200 Milliohms
Insulation Resistance (Min.)	10 <sup>12</sup> ohms
Contact Capacitance (pf Max.)	0.2 pf

- The specification for VA rating may sometimes be exceeded for less sensitive (higher AT) switches, and should be decreased for very sensitive (lower AT) switches.
- Breakdown voltage is measured in the presence of an ionising source. Switch leakage current is limited to 100 microamperes.
- Contact resistance measurements are made at 10ma from a 1-volt source, with 50% overdrive, using a 4-wire (Kelvin) measuring system. Contact probes are located on 43 mm centres.

### Minimum Switching Life with Standard Test Loads, using 20AT switch:

Voltage	12 VDC	100 VDC
Current	10 mA	100 mA
Life	> 2 million	> 1 million

Note: End of life is defined as contact resistance exceeding one ohm and/or failure to operate.

## Operating Characteristics:

Magnetic Sensitivity (Range - Pull In)	10 to 35 Ampere Turns
Magnetic Sensitivity (Range – Drop Out)	20 to 98% of Pull In
Operate Time, including bounce (typ.)	0.8 Milliseconds
Release Time (typ.)	0.1 Milliseconds
Resonant Frequency (typ.)	2.2 kHz
Vibration, 10-2,000 Hz (G's Max.)	40 G
Shock, 11-ms. 1/2 Sine wave (G's Max.)	100 G
Operating Temperature	-40°C to + 125°C
Storage Temperature	-50°C to + 155°C

## Charts:

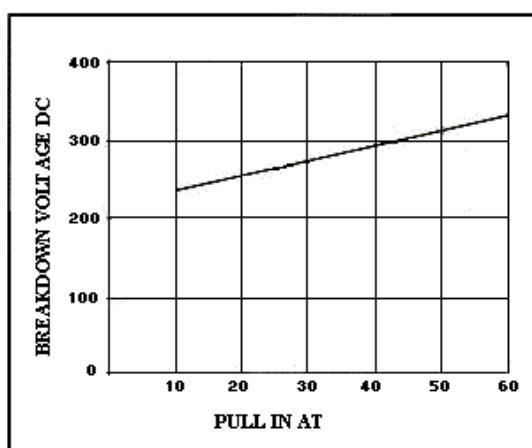

Breakdown Voltage Plotted Against Pull-In Ampere Turns

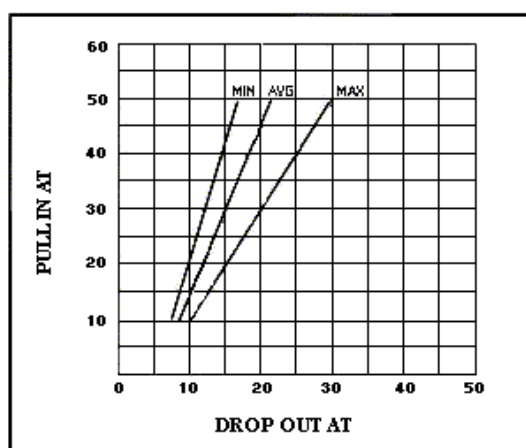

Pull-In Ampere Turns Plotted Against Drop-Out Ampere Turns

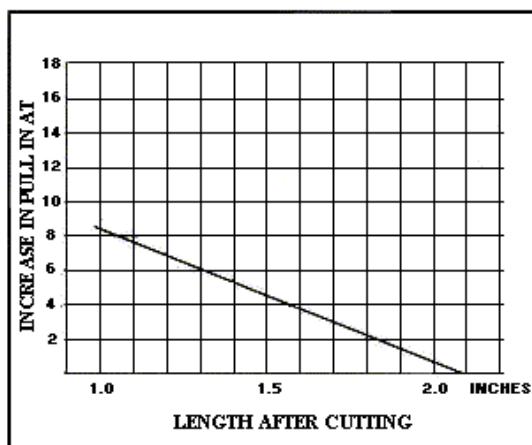

Change In Pull-In Ampere Turns After Switch Lead Cutting

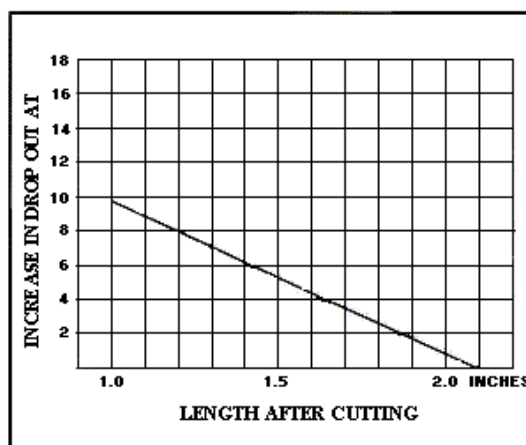

Change In Drop-Out Ampere Turns After Switch Lead Cutting

© **Standex Electronics Inc.**

[www.StandexElectronics.com](http://www.StandexElectronics.com)

Cincinnati, Ohio USA  
Phone +513 871 3777  
Fax +513 871 3779

Tonbridge, United Kingdom  
Phone +44 1732 77 10 23  
Fax +44 1732 77 01 22

Tianjin, China  
Tel: +86 22 86 99 68 81-5  
Fax: +86 22 86 99 68 86

## Reed switch structure and operation:

The form A reed switch comprises of two ferromagnetic reeds placed with a gap in-between and hermetically sealed in a glass tube. The glass tube is filled with an inert gas, (nitrogen), or a vacuum to prevent the oxidation of the contacts. The surfaces of the reed contacts are plated with metals from the platinum group such as rhodium, ruthenium, palladium or iridium either by electroplating or sputtering.

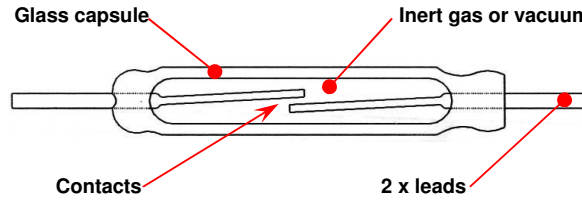

The reed switch is operated by the magnetic field of an energised coil or a permanent magnet which induces north (N) and south (S) poles on the reeds. The reed contacts are closed by this magnetic attractive force. When the magnetic field is removed, the reed elasticity causes the contacts to open the circuit

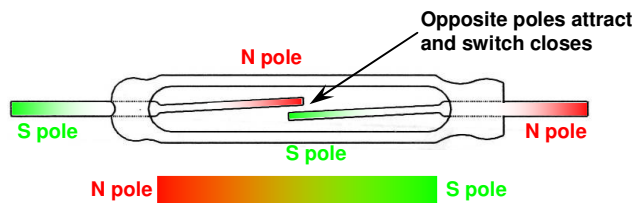

## Reed switch actuation:

In all systems, magnet and reed switch must be brought to within a specific proximity of each other. This distance will vary in accordance with the sensitivity of the reed switch, the amount of lead that is cropped and the strength of the magnet. As the lead is cut the switch sensitivity decreases as there is less ferro-magnetic material to attract the magnet flux. When the magnet is close enough, the normally open contacts will close, when the magnet is removed the contacts will open. The relative distance for operation is always less than that for a release. Examples of proximity motion switching are shown below:

Provides only one closure with maximum magnet travel:

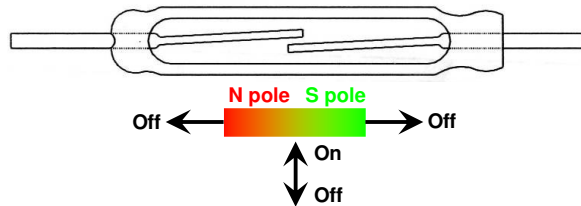

Provides as many as three closures with maximum magnet travel:

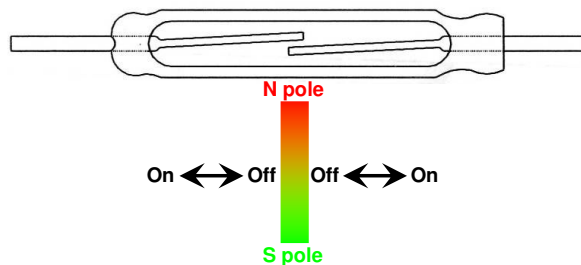

Ring magnet actuation allows one closure with minimum magnet travel.

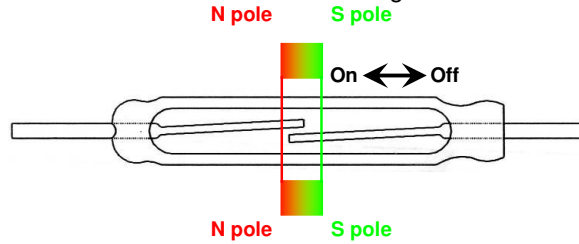

Large angular magnet travel necessary to achieve one switch closure.

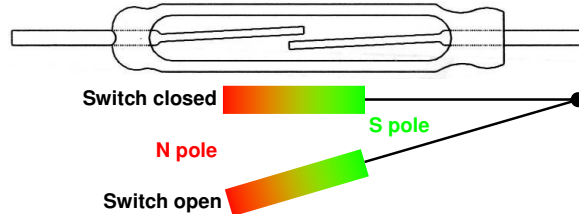

Rotating the magnet or reed switch, normal to their axes, reverses magnetic polarity resulting in two closures per revolution. When these axes are parallel, the switch closes. When the axes are perpendicular, the switch opens. Although the poles reverse, they still induce the opposite poles that close the reed switch.

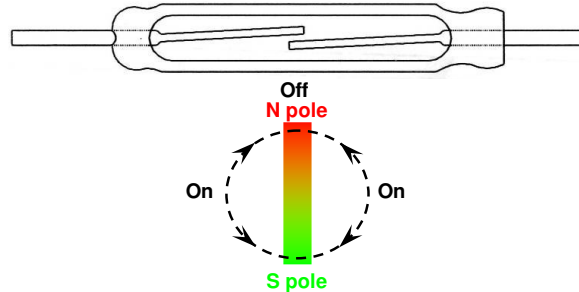

A biasing effect is produced by placing a stationary magnet near the reed switch, to keep it normally closed. The approach of another magnet with reversed polarity cancels the magnetic lines of force, and the reed switch opens. Care should be taken not to bring the actuating magnet too close to the biased reed switch, as it could close again. The same effect can be achieved using only two leads of a form C switch.

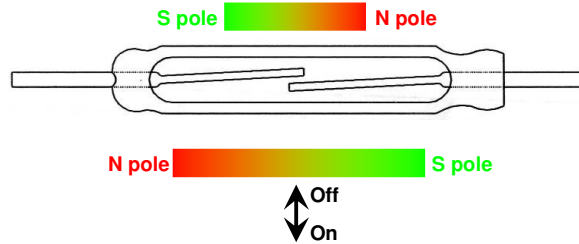

In this type of actuation, magnet and reed switch are permanently fixed in such a position that the reed switch contacts are closed. A piece of ferromagnetic material is passed between the magnet and the reed switch, to cause drop out. The magnetic field is shunted, eliminating the attraction between the reeds. When the shield is removed, the reed switch closes.

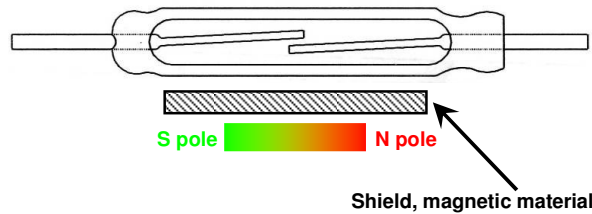



## Typical applications for reed switches are:

- Proximity sensors.
- General fluid level sensors including the following automotive specific applications:
  - Brake fluid level.
  - Windscreen washer fluid level.
  - Engine coolant fluid level.
- Flow sensors.
- Reed relays.
- Pedometers.
- Bicycle computers.
- Exercise machines.
- Gas, water and electricity meters.
- Rice cookers.
- Security, (door and window contacts).
- Electric toothbrushes.
- Humidifiers.

## Glossary:

### Ampere Turn (AT):

The product of the number of turns of wire in an electromagnetic coil winding and the current in amperes passing through the winding. This is a direct measure of the magnetic field generated, and of a reed contact's sensitivity.

### Bounce:

Intermittent opening and closing of closed contacts or closing and opening of open contacts, usually implying the motion resulting from contact impact.

### Bounce Time (in milliseconds):

Time taken for a bounce.

### Breakdown Voltage:

The voltage which may be applied between insulated parts of a reed contact without damage, arcing, breakdown, or causing excessive leakage.

### Carry Current (in Amps):

The maximum current that can be applied to an already closed contact.

### Contact Rating (in Watts):

The maximum power, a reed contact can switch.

### Contact Resistance (CR):

The electrical resistance of closed contacts.

### Curie temperature:

Temperature at which a magnet is totally demagnetized.

### Differential:

The difference between operate AT and release AT often expressed as %.

### Drop Out (DO):

See Release AT.

### Form A:

A normally open type of reed contact.

### Form B:

A normally closed type of reed contact.

### Form C:

A change-over type of reed contact where break happens before make.

### Form D:

A change-over type of reed contact where make happens before break.

### Form E:

A latching, or bi-stable type of contact, which stays in the last energised state, without the need for maintaining the field.

Hysteresis:  
See differential.

Insulation Resistance:  
The electrical resistance measured between insulated terminals.

Omni-polar:  
A type of device that will function with either pole of a magnet.

Operate AT (OAT):  
The measured value, in AT, at which a reed contact closes. This is valid for the closing operation of form A, B, and E type reed contacts and the change over operation from the normally closed contact to the normally open contact for form C and D type reed contacts.

Operating Temperature:  
The temperature range over which the reed contact will meet all specified operating parameters.

Operate Time:  
The time interval from coil energisation, to the closing of the reed contact. Where not otherwise stated, the functioning time of the reed contact in question is taken as its initial functioning time, not including contact bounce.

Over-drive (in AT):  
The AT given above OAT, before measurement of CR.

Pull In (PI):  
See Operate AT.

Release AT (RAT):  
The measured value, in AT, at which a reed contact opens. This is valid for the opening of form A, B, and E type reed contacts, and the change over from the closed normally open contact to the open normally closed contact for form C and D type contacts.

Release Time:  
The time interval from coil de-energisation to the opening or change over of the reed contact. Where not otherwise stated, the functioning time of the reed contact in question is taken as its initial functioning time, not including contact bounce.

Resonance Frequency (in Hz):  
The frequency where a reed contact will chatter, or starts sympathetic vibration.

Saturation:  
Magnetic saturation exists when an increase of magnetisation applied to a reed contact does not increase the magnetic flux.

Switching Voltage (in Volts):  
The maximum voltage a reed contact can switch.

Switching Current (in Amps):  
The maximum current a reed contact can switch.